



Manual

Model **1253**

Hydraulic Pump Motor Controller



Curtis Instruments, Inc.
200 Kisco Avenue
Mt. Kisco, NY 10549
www.curtisinstruments.com



Read Instructions Carefully!

Specifications are subject to change without notice.

© 2015 Curtis Instruments, Inc. © Curtis is a registered trademark of Curtis Instruments, Inc.

© The design and appearance of the products depicted herein are the copyright of Curtis Instruments, Inc.

38329 Rev F 2/15

The Curtis Difference 
You feel it when you drive it

CONTENTS

| | |
|--|----|
| 1. OVERVIEW | 1 |
| 2. INSTALLATION AND WIRING | 3 |
| Mounting the Controller | 3 |
| Low Current Connections..... | 5 |
| High Current Connections | 6 |
| Wiring: Standard Configuration..... | 7 |
| Wiring: Throttles..... | 11 |
| Contactor, Switches, and Other Hardware..... | 13 |
| 3. PROGRAMMABLE PARAMETERS | 15 |
| Speed Parameters..... | 16 |
| Maximum Speed, SS1–SS4 | 16 |
| Throttle Maximum Speed..... | 16 |
| Minimum Speed..... | 16 |
| Acceleration Rate..... | 16 |
| Throttle Parameters | 16 |
| Throttle Type..... | 16 |
| Throttle Deadband | 17 |
| Throttle Maximum | 18 |
| Throttle Map | 20 |
| Final Speed Request Parameters | 22 |
| SS Add Mode | 22 |
| Final Add Mode | 23 |
| SS High Speed On | 24 |
| Fault Parameters..... | 25 |
| Lift Lockout Type..... | 25 |
| Lift Lockout, SS1–SS4 | 25 |
| Lift Lockout, Throttle..... | 25 |
| Throttle Fault Detection..... | 26 |
| Startup Lockout..... | 26 |
| Undervoltage Parameters..... | 27 |
| Low Voltage Cutback | 27 |
| Low Voltage Cutback Rate | 27 |
| Contactor Control Parameters | 27 |
| Pump Contactor Control | 27 |
| Contactor Pull-in Voltage | 27 |
| Contactor Holding Voltage..... | 27 |
| SS4 Delay..... | 28 |
| Interlock Delay..... | 28 |
| Precharge..... | 28 |
| Precharge Delay..... | 28 |

| | |
|--|----|
| Current Limit Parameter..... | 29 |
| Main Current Limit (x10A)..... | 29 |
| 4. INSTALLATION CHECKOUT..... | 30 |
| 5. DIAGNOSTICS AND TROUBLESHOOTING..... | 32 |
| Programmer Diagnostics..... | 32 |
| LED Diagnostics..... | 34 |
| 6. MAINTENANCE..... | 35 |
| | |
| APPENDIX A Vehicle Design Considerations | |
| APPENDIX B Programming Devices and Menus | |
| APPENDIX C Specifications, Curtis 1253 Controller | |

FIGURES

| | | |
|----------|---|----|
| FIG. 1: | Curtis 1253 hydraulic system controller..... | 1 |
| FIG. 2: | Mounting dimensions, Curtis 1253 controller | 3 |
| FIG. 3a: | Standard wiring configuration, using Curtis 803 gauge for lift lockout..... | 7 |
| FIG. 3b: | Standard wiring configuration, using Curtis 906 gauge for lift lockout..... | 8 |
| FIG. 3c: | Standard wiring configuration, using Curtis 841 “Superspy” for lift lockout..... | 9 |
| FIG. 3d: | Standard wiring configuration, using Curtis enGage™ IV for lift lockout | 10 |
| FIG. 4: | Wiring for 2-wire 5kΩ–0 potentiometer (“Type 0”) | 12 |
| FIG. 5: | Wiring for 2-wire 0–5kΩ potentiometer (“Type 1”) | 12 |
| FIG. 6: | Wiring for single-ended 0–5V input (“Type 2”) | 13 |
| FIG. 7: | Wiring for single-ended 1–10kΩ 3-wire pot (“Type 3”) | 13 |
| FIG. 8: | Effect of adjusting the throttle deadband parameter | 17 |
| FIG. 9: | Effect of adjusting the throttle max parameter | 19 |
| FIG. 10: | Throttle maps for controller with maximum speed set at 100% | 20 |
| FIG. 11: | Throttle maps for controller with maximum speed set at 80% | 21 |
| FIG. 12: | Influence of various parameters on controller output response to throttle demand | 21 |
| FIG. 13: | Speed conditioning | 23 |
| FIG. 14: | SS High Speed On speed conditioning | 24 |
| FIG. 15: | Bench test setup | 31 |

TABLES

| | |
|--|-----|
| TABLE 1: Throttle wiper input (threshold values)..... | 11 |
| TABLE 2: Programmable throttle input signal types..... | 17 |
| TABLE 3: Programmable lift lockout signal types | 25 |
| TABLE 4: Precharge function and fault detection..... | 28 |
| TABLE 5: Troubleshooting chart..... | 33 |
| TABLE 6: Status LED fault codes | 34 |
| TABLE C-1: Specifications, 1253 controller | C-1 |

1

OVERVIEW

The Curtis 1253 provides a cost-effective solution for control of high power DC series-wound hydraulic pump motors. Its system integration features are designed primarily for Class I and Class II material handling vehicles. Typical applications include the pump systems of material handling trucks (counter-balance trucks, reach trucks), aerial lift platforms (scissor lifts, articulating/telescoping booms), and other industrial vehicles.

The 1253 accepts inputs from up to four Speed Select switches and also from an analog throttle. Its internal microprocessor-based logic controller provides maximum flexibility at minimum cost. Its performance characteristics can be tailored through an array of programmable parameters.

The 1253 controller is fully programmable through a Curtis handheld programmer or PC Programming Station. The programming device provides diagnostic and test capability in addition to configuration flexibility.

Fig. 1 *Curtis 1253 hydraulic pump motor controller.*



Like all Curtis motor controllers, the 1253 offers superior operator control of motor speed and torque.

Smooth and Quiet Control

- ✓ Programmable acceleration rates provide smooth application of pump motor torque
- ✓ 15.6 kHz PWM frequency for near-silent operation.

Programmable Flexibility

- ✓ Easily programmable through a Curtis programming device
- ✓ Four Speed Select inputs (SS1–SS4) with individually programmable top speeds
- ✓ Programmable throttle input for precise speed control with a variety of signal sources
- ✓ Programmable turn-off delay allows SS4 to be used for power steering
- ✓ Adjustable minimum speed setting to ensure pump lubrication and to maintain steering system pressure
- ✓ SS High Speed On mode enhances speed stability (*1253-4804 only*).

Robust Safety and Reliability

- ✓ Interlock feature disables the controller when operator is not present
- ✓ Programmable startup lockout prevents inadvertent operation
- ✓ Seamless integration with Curtis gauges (models 803, 841, 906, and enGage™ IV) for lift lockout function
- ✓ Lift lockout disables the controller at low battery state of charge
- ✓ Redundant watchdog timer circuits ensure proper software operation
- ✓ External Status LED output for easy troubleshooting
- ✓ Short-circuit protection on main contactor driver
- ✓ Precharge control prevents pitting of contactor tips at startup
- ✓ Thermal cutback provides protection to the controller
- ✓ Rugged housing meets IP54 environmental ratings
- ✓ Full-power operation over the -40°C – 80°C heatsink temperature range.

Familiarity with your Curtis controller will help you install and operate it properly. We encourage you to read this manual carefully. If you have questions, please contact the Curtis office nearest you.

2

INSTALLATION AND WIRING

MOUNTING THE CONTROLLER

The 1253 controller can be oriented in any position, and meets the IP54 ratings for environmental protection against dust and water. However, **the location should be carefully chosen to keep the controller clean and dry. If a clean, dry mounting location cannot be found, a cover must be used to shield the controller from water and contaminants.**

The controller's outline and mounting hole dimensions are shown in Figure 2. When selecting the mounting position, be sure to also take into consideration that access is needed at the end of the controller to plug the programmer into its connector.

To ensure full rated power, the controller should be fastened to a clean, flat metal surface with four 6 mm (1/4") diameter screws, using the holes

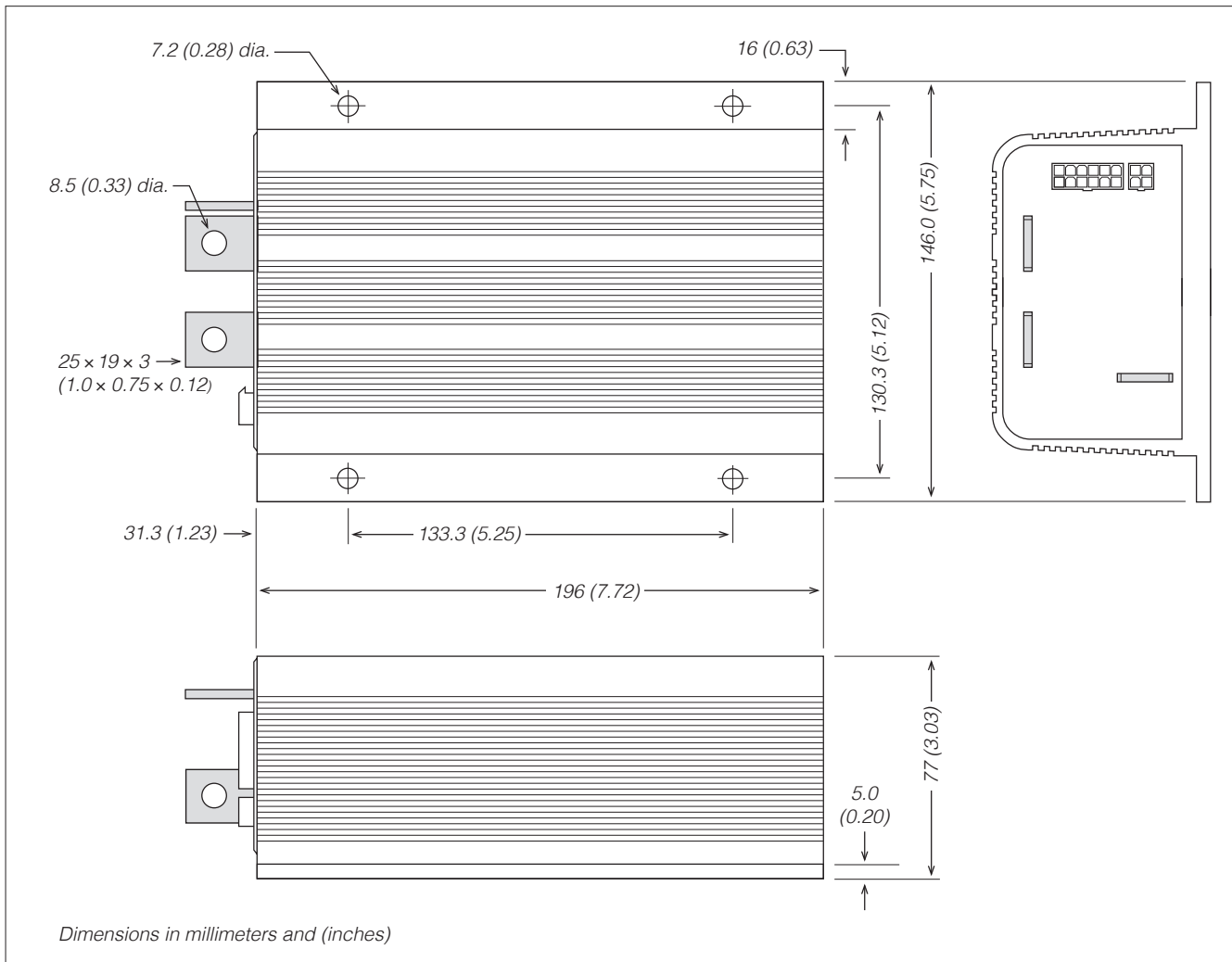

Fig. 2 Mounting dimensions, Curtis 1253 controller.

provided. Although not usually necessary, a thermal joint compound can be used to improve heat conduction from the controller heatsink to the mounting surface.

You will need to take steps during the design and development of your end product to ensure that its EMC performance complies with applicable regulations; suggestions are presented in Appendix A.



Working on electrical systems is potentially dangerous. You should protect yourself against uncontrolled operation, high current arcs, and outgassing from lead acid batteries:

UNCONTROLLED OPERATION — Some conditions could cause the hydraulic pump system to run out of control. **Disconnect the motor or make sure the pump system has enough room to operate** before attempting any work on the motor control circuitry. Note: If the wrong throttle input signal type is selected with the programming device, the pump system may suddenly begin to operate.

HIGH CURRENT ARCS — Batteries can supply very high power, and arcs can occur if they are short circuited. Always open the battery circuit before working on the motor control circuit. **Wear safety glasses, and use properly insulated tools to prevent shorts.**

LEAD ACID BATTERIES — Charging or discharging generates hydrogen gas, which can build up in and around the batteries. Follow the battery manufacturer's safety recommendations. **Wear safety glasses.**

LOW CURRENT CONNECTIONS

Two low current connectors are built into the 1253 controller. They are located on the end of the controller:

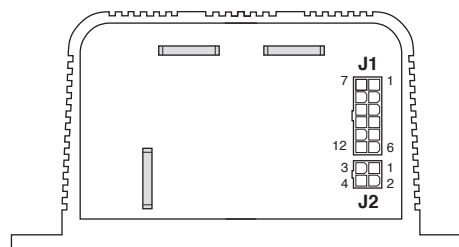

The 12-pin connector (J1) provides the logic control connections. The mating connector is a 12-pin Molex Mini-Fit Jr. connector part number 39-01-2125 using type 5556 terminals.

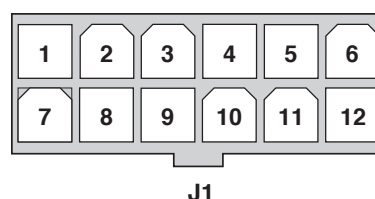

| | | |
|-------|-----------------------|---|
| J1-1 | Keyswitch Input (KSI) | <i>input and return for main contactor coil</i> |
| J1-2 | Pot High | <i>+5V supply</i> |
| J1-3 | Pot Wiper | <i>pot wiper input (or 5V throttle input)</i> |
| J1-4 | Pot Low | <i>to ground through 511 ohm resistor</i> |
| J1-5 | Interlock | <i>input from operator-present switch, tied to B+</i> |
| J1-6 | Status LED | <i>LED driver low-side output</i> |
| J1-7 | SS1 | <i>Speed Select 1 input</i> |
| J1-8 | SS2 | <i>Speed Select 2 input</i> |
| J1-9 | SS3 | <i>Speed Select 3 input</i> |
| J1-10 | SS4 | <i>Speed Select 4 input</i> |
| J1-11 | Lift Lockout | <i>input to the inhibit lift feature</i> |
| J1-12 | Contactor | <i>main contactor coil driver low-side output</i> |

J2-1 Rx Data
J2-2 B-
J2-3 Tx Data
J2-4 +15V

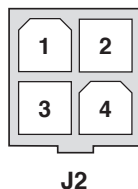

The 4-pin connector (J2) is for the programmer—either the 1311 handheld programmer or the 1314 PC Programming Station. A complete programmer kit with the appropriate connecting cable can be ordered:

Curtis p/n 168961101 for the User Programmer (model 1307M-1101)

Curtis p/n 168962101 for the OEM Programmer (model 1307M-2101).

If a handheld programmer is already available but has an incompatible cable, the 1253 mating cable can be ordered as a separate part: Curtis p/n 16185.

With a 1314 PC programming station, the 1309 interface box and cable connect the computer to the controller:

p/n 117465704 1314-1101, 1314 PC Programming Station (User) CD-ROM

p/n 117465707 1314-4401, 1314 PC Programming Station (OEM) CD-ROM

p/n 16994001 1309 Interface Box

p/n 16185 Molex cable for 1309 Interface Box.

NOTE: The 1311 handheld programmer has been superseded; if you are using a more recent model, please refer to its documentation.

HIGH CURRENT CONNECTIONS

Three tin-plated solid copper bus bars are provided for the high current connections to the battery (**B+** and **B-**) and the motor armature (**M-**).

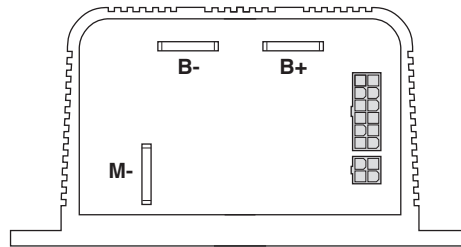

WIRING: Standard Configuration

Figure 3 shows the typical wiring configuration for most applications. The interlock switch is typically a seat switch, tiller switch, or foot switch. The throttle shown is a 3-wire pot; other types of throttles can also be used.

Lift lockout can be provided through any of four Curtis gauges:

- (a) Curtis 803
- (b) Curtis 906
- (c) Curtis 841 “Superspy”
- (d) Curtis enGage™ IV.

As each of these gauges is wired somewhat differently to provide lift lockout, four individual wiring diagrams are included (Figs. 3a, 3b, 3c, 3d).

Power Wiring

Motor wiring is straightforward, with the field’s S1 connection going to the controller’s **B+** bus bar and the armature’s A2 connection going to the controller’s **M-** bus bar.

Control Wiring

The main contactor coil should be wired directly to the controller as shown in Figure 3. The controller uses the main contactor coil driver output to remove power from the controller and pump motor in the event of various faults. **If the main contactor coil is not wired to Pin 12, the controller will not be able to open the main contactor in serious fault conditions.**



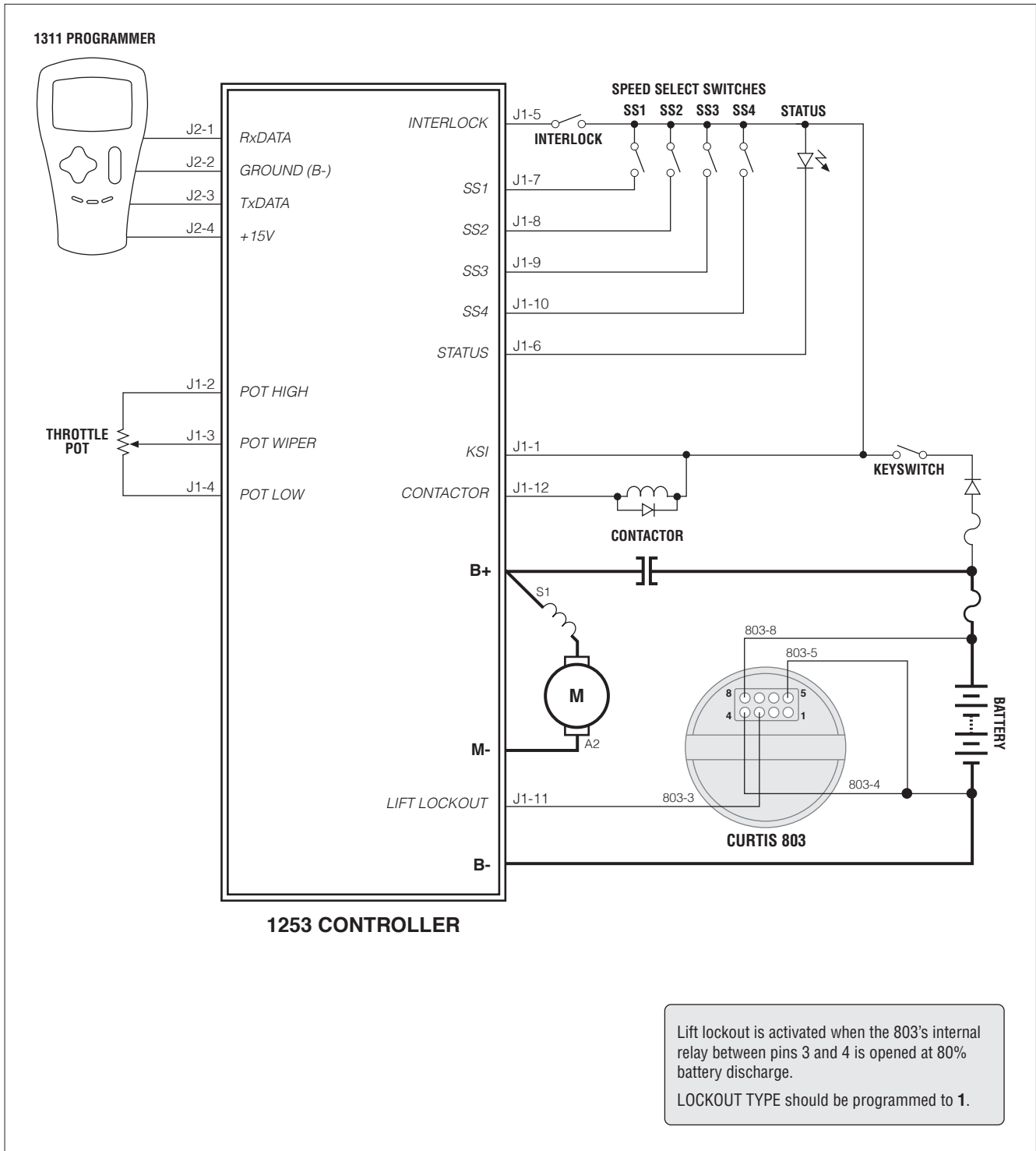

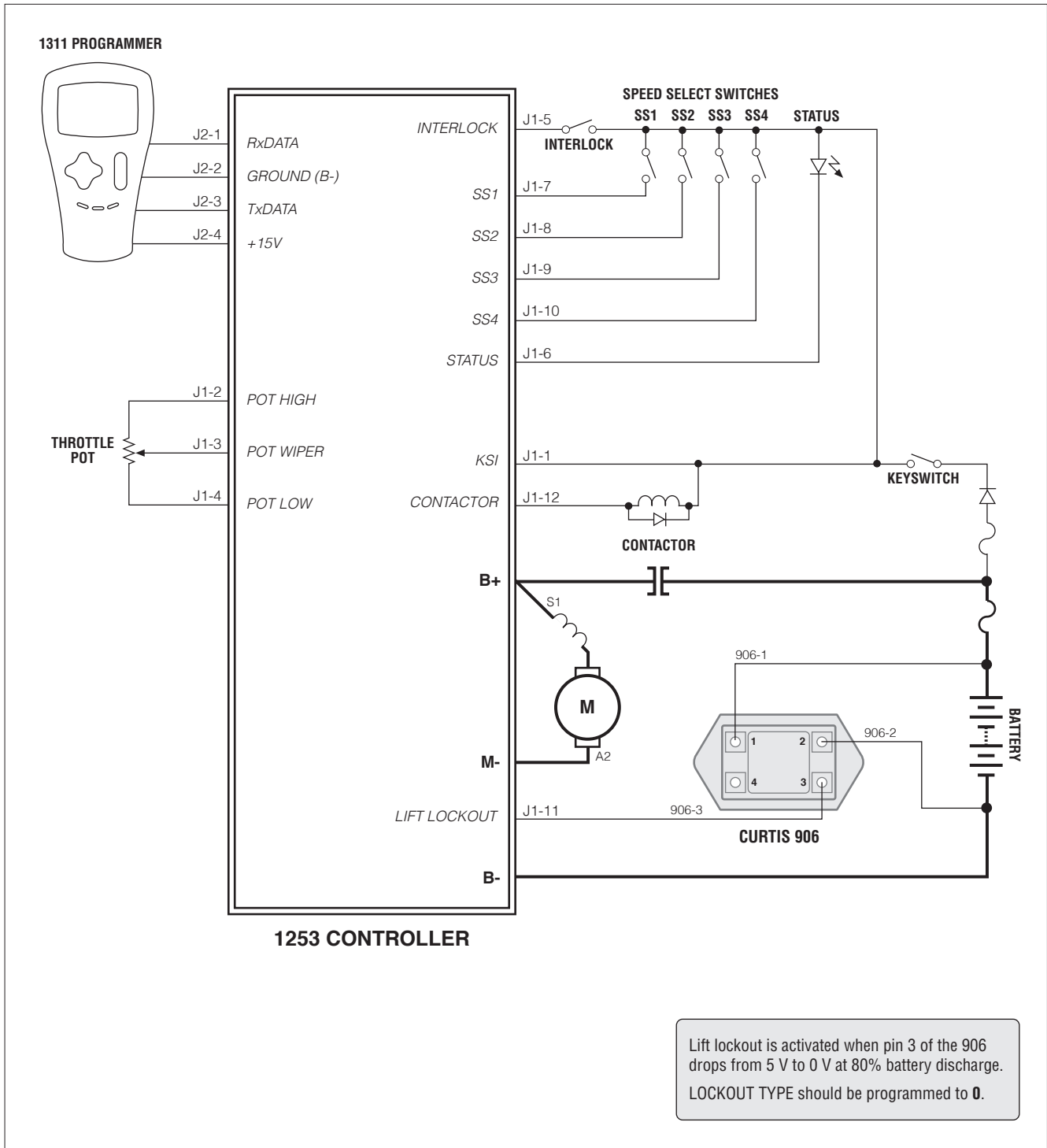

Fig. 3b Standard wiring configuration, Curtis 1253 controller with Curtis 906 providing lift lockout.

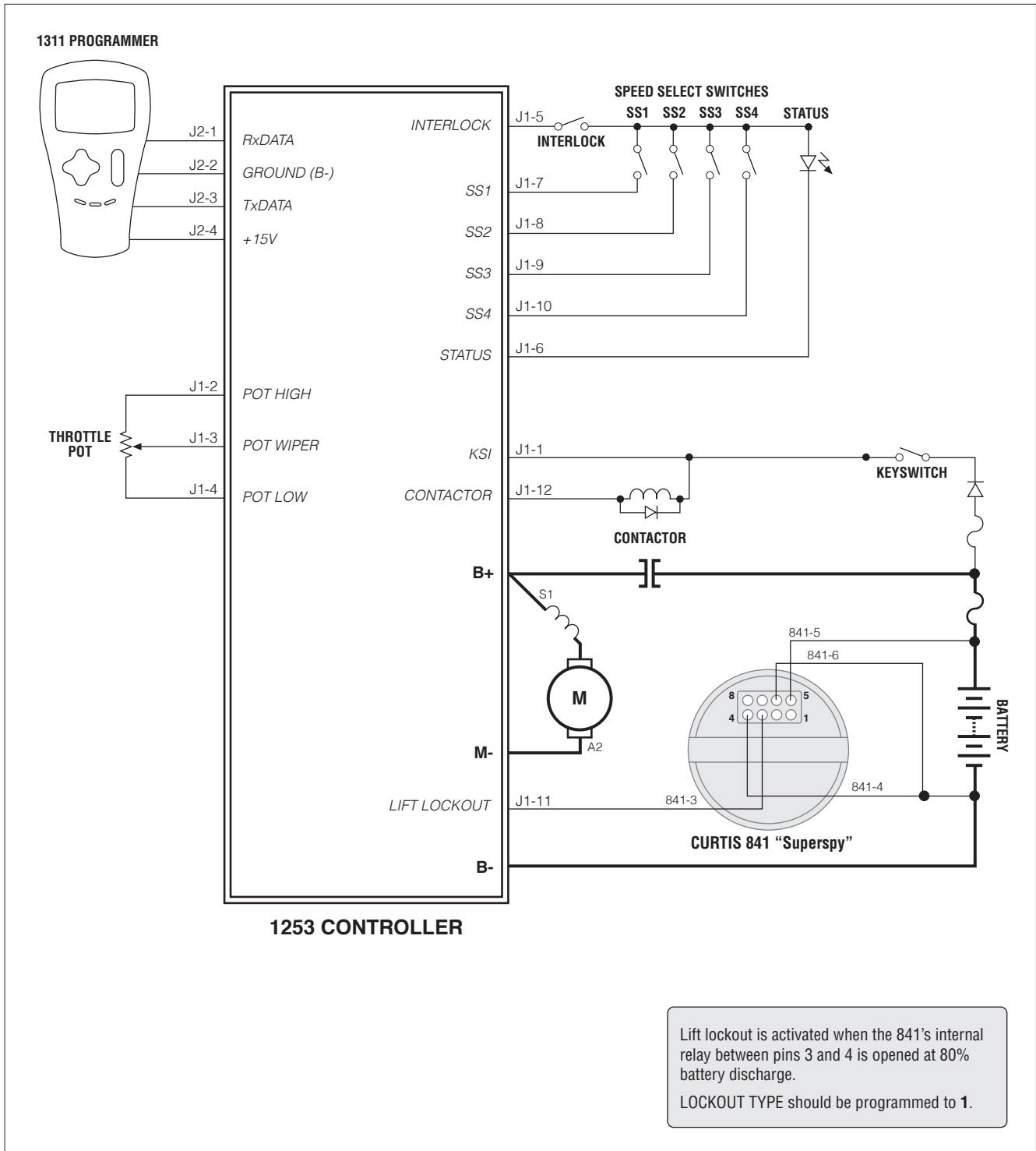

Fig. 3c Standard wiring configuration, Curtis 1253 controller with Curtis 841 "Superspy" providing lift lockout.

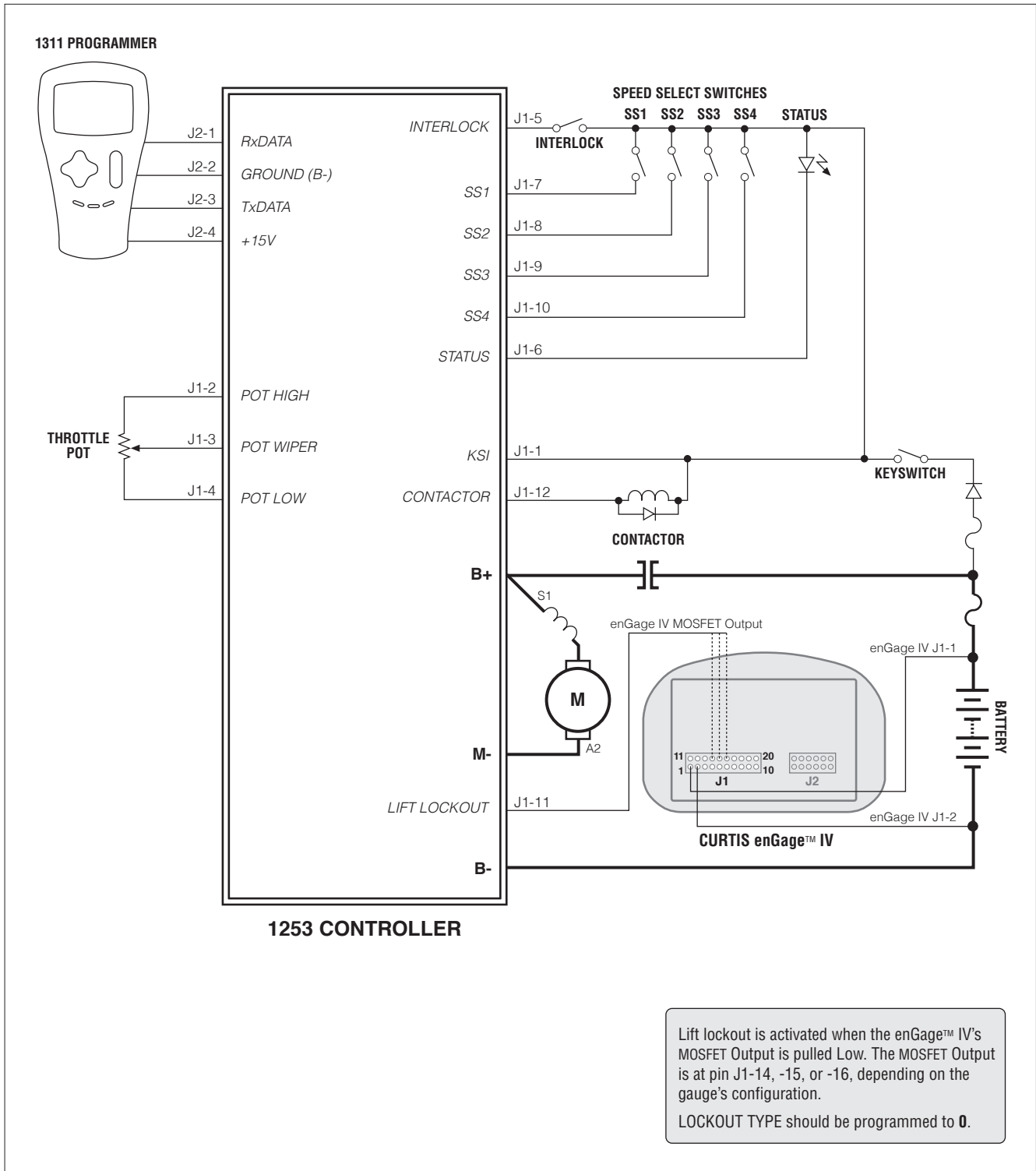

Fig. 3d Standard wiring configuration, Curtis 1253 controller with Curtis enGage™ IV providing lift lockout.

WIRING: Throttles

Various throttles can be used with the 1253 controller. They are categorized as one of four types in the Program Menu.

Type 0: two-wire 0–5k Ω potentiometer throttles

Type 1: two-wire 5k Ω –0 potentiometer throttles

Type 2: single-ended 0–5V throttles

Type 3: single-ended three-wire 1k Ω –10k Ω pot throttles.

Table 1 summarizes the operating specifications for these four throttle types.

| THROTTLE TYPE | PARAMETER | MINIMUM THROTTLE FAULT | THROTTLE DEADBAND (0% speed request) | STARTUP LOCKOUT | THROTTLE MAX (100% modulation) | MAXIMUM THROTTLE FAULT |
|---------------|------------------|------------------------|--------------------------------------|-----------------|--------------------------------|------------------------|
| 0 | Wiper Voltage | — | 0.6 V | out of deadband | 4.5 V | 5.7 V |
| | Wiper Resistance | — | 0 k Ω | | 5.0 k Ω | 7.5 k Ω |
| 1 | Wiper Voltage | — | 4.5 V | out of deadband | 0.6 V | 5.7 V |
| | Wiper Resistance | — | 5.0 k Ω | | 0 k Ω | 7.5 k Ω |
| 2 | Wiper Voltage | — | 0 V | out of deadband | 5.0 V | 5.5 V |
| | Wiper Resistance | — | — | | — | — |
| 3 | Wiper Voltage | 0.4 V | 0.5 V | out of deadband | 5.0 V | 5.5 V |
| | Wiper Resistance | — | 0 k Ω | | 5.0 k Ω | — |

Notes: The upper and lower deadbands are valid for nominal 5k Ω potentiometers or 5V sources with the default Throttle Deadband and Throttle Max parameter settings of 0% and 100% respectively. These values will change with variations in the Throttle Deadband and Throttle Max parameter settings—see Section 3, pages 17 and 18.

The startup lockout threshold for all throttle types is set by the Throttle Deadband.

For *potentiometers*, the 1253 provides complete throttle fault protection that meets all applicable EEC regulations. For *voltage throttles*, the 1253 protects against out-of-range wiper voltages (see Table 1), but does not detect wiring faults; it is therefore the responsibility of the OEM to provide full throttle fault protection in vehicles using voltage throttles.

Wiring for the most common throttles is described below. If the throttle you are planning to use is not covered, contact the Curtis office nearest you.

Note: In the text, throttles are identified by their nominal range (e.g., 5k Ω –0 pot) and not by their actual operating range.

0–5k Ω Throttle (“Type 0”)

The 0–5k Ω throttle (“Type 0” in the Program Menu) is a 2-wire resistive throttle that connects between the Pot Wiper and Pot Low pins, as shown in Figure 4. Zero speed corresponds to 0 Ω measured between the two pins and full speed corresponds to 5 k Ω .

Fig. 4 Wiring for 0–5k Ω throttle (“Type 0”).

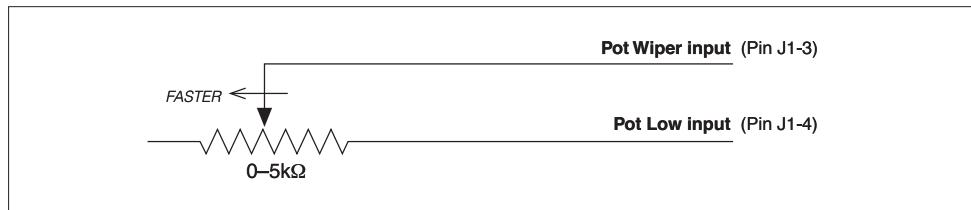

If the total resistance between the Pot Wiper and Pot Low pins is greater than 7.5 k Ω , the controller’s upper fault limit will be exceeded (see Table 1) and the throttle’s input value will be zeroed. This provides broken wire protection, and also serves as an indication that the potentiometer’s resistance has increased beyond the acceptable range and that the pot therefore needs to be replaced.

5k Ω –0 Throttle (“Type 1”)

The 5k Ω –0 throttle (“Type 1” in the Program Menu) is a 2-wire resistive throttle that connects between the Pot Wiper and Pot Low pins, as shown in Figure 5. Zero speed corresponds to a nominal 5k Ω measured between the two pins and full speed corresponds to 0 Ω .

Fig. 5 Wiring for 5k Ω –0 throttle (“Type 1”).

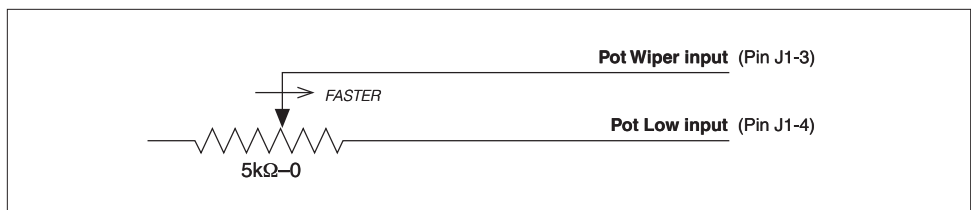

If the total resistance between the Pot Wiper and Pot Low pins is greater than 7.5 k Ω , the controller’s upper fault limit will be exceeded (see Table 1) and the throttle’s input value will be zeroed. This provides broken wire protection, and also serves as an indication that the potentiometer’s resistance has increased beyond the acceptable range and that the pot therefore needs to be replaced.

Single-Ended 0–5V Voltage Source (“Type 2”)

With this throttle (“Type 2” in the Program Menu) the controller looks for a voltage signal at the Pot Wiper pin. Zero speed corresponds to 0V and full speed to 5V.

Fig. 6 *Wiring for 0–5V throttles (“Type 2”).*

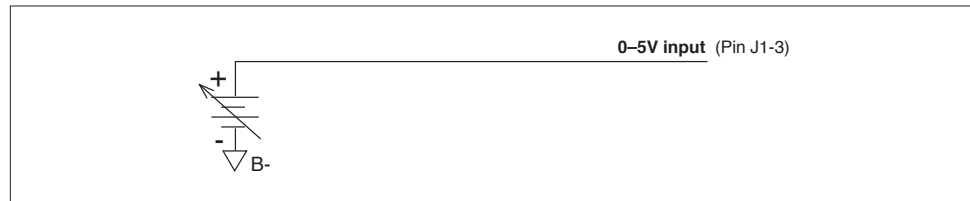

The active range for this throttle is from 0 V (at 0% Throttle Deadband) to 5.0V (at 100% Throttle Max), measured relative to B-. The signal is measured at the Pot Wiper pin. It is the responsibility of the OEM to provide appropriate throttle fault detection for 0–5V throttles.

Single-Ended 1kΩ–10kΩ 3-wire pot (“Type 3”)

The 3-wire potentiometer is used in its voltage divider mode, with the voltage source and return being provided by the 1253 controller. Pot High provides a current limited 5V source to the pot, and Pot Low provides the return path. Wiring is shown in Figure 7 and is also shown in the standard wiring diagrams, Figure 3.

Fig. 7 *Wiring for 3-wire potentiometer throttle (“Type 3”).*

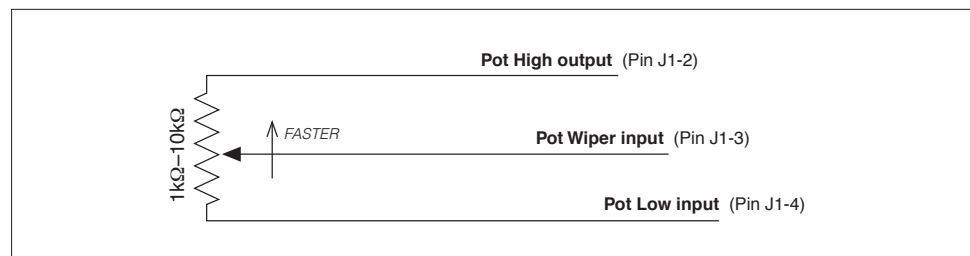

When a 3-wire pot is used, the controller provides full fault protection. Potentiometers with total resistance values between 1 kΩ and 10 kΩ can be used.

CONTACTOR, SWITCHES, and OTHER HARDWARE

Main Contactor

A main contactor should be used with the 1253 controller. Otherwise, the controller’s fault detection will not be able to fully protect the controller and hydraulic system from damage in a fault condition. The main contactor allows the controller and motor to be disconnected from the battery. This provides a significant safety feature, because it means the battery power can be removed

from the hydraulic system if a controller or wiring fault results in battery power being applied to the motor inappropriately.

The 1253 provides a low-side contactor coil driver (at Pin J1-12) for the main contactor. The driver output is rated at 1 amp and is short-circuit protected. It is recommended that a coil suppression diode be included, as shown in the wiring diagrams. This protects the contactor coil driver from inductive voltage kickback spikes when the contactor is turned off.

Keyswitch and Interlock Switch

The vehicle should have a master on/off switch to turn the system off when not in use. The keyswitch input provides logic power for the controller.

The interlock switch, which is typically implemented as a seatswitch or a hand/foot activated deadman switch, provides a safety interlock to ensure that an operator is present in order for the system to run.

The keyswitch and interlock switch provide current to drive the main contactor coil as well as the controller's internal logic circuitry, and must be rated to carry these currents.

Speed Select Switches

These input switches can be any type of single-pole, single-throw (SPST) switch capable of switching the battery voltage at 25 mA.

Reverse Polarity Protection Diode

For reverse polarity protection, a diode should be added to the control circuit. This diode will prohibit main contactor operation and current flow if the battery pack is accidentally wired with the B+ and B- terminals reversed. It should be sized appropriately for the maximum contactor coil current required from the control circuit. The reverse polarity protection diode should be wired as shown in the standard wiring diagrams (Figure 3).

Circuitry Protection Devices

To protect the control circuitry from accidental shorts, a low current fuse (appropriate for the maximum current draw) should be connected in series with the battery feed to the keyswitch. Additionally, a high current fuse should be wired in series with the main contactor to protect the motor, controller, and batteries from accidental shorts in the power system. The appropriate fuse for each application should be selected with the help of a reputable fuse manufacturer or dealer. The standard wiring diagrams (Figure 3) show the recommended location for each fuse.

3

PROGRAMMABLE PARAMETERS

The 1253's programmable parameters allow the pump system's performance characteristics to be customized to fit the needs of individual applications or system operators. Programming can be done with a 1311 handheld programmer or a 1314 PC Programming Station. The discontinued 1307 handheld programmer is also fully compatible with the 1253 controller.

NOTE: The 1311 handheld programmer has been superseded; if you are using a more recent model, please refer to its documentation.

Curtis offers two versions of the 1311 programmer: the 1311-1101 is the User programmer (which can adjust only those parameters with User access rights) and the 1311-4401 is the OEM programmer (which can adjust all the parameters with User or OEM access rights). Similarly, the 1314 PC Programming Station software is available in two versions: 1314-1101 and 1314-4401. See Appendix B for more information about the programmers.

In the following descriptions, the 1253's parameters are arranged in groups. The parameter names are listed here in the abbreviated forms that appear on the handheld programmer's 14-character LCD screen. Not all of these parameters are available on all controllers; the parameters for any given controller are dependent on its specifications.

For a list of the parameters in the order in which they appear in the Program Menu, see Appendix B.

Speed Parameters

SPEED (SS1-SS4)
THRTL MAX SPD
MINIMUM SPEED
ACCEL RATE

Throttle Parameters

THROTTLE TYPE
THRTL DEADBAND
THROTTLE MAX
THROTTLE MAP

Final Speed Request Parameters

SS ADD MODE
FINAL ADD MODE
SS HIGH SPEED ON

Fault Parameters

LOCKOUT TYPE
LIFT LOCK (SS1-SS4)
THRTL LIFTLOCK
THRTL FAULT
STARTUP LOCK

Undervoltage Parameters

LOVOLT CUTBACK
LOVOLT CB RATE

Contactors Driver Parameters

CONTACT CNTRL
CONT PULL IN
CONT HOLDING
SS4 DELAY
INTERLOCK DLY
PRECHARGE
PRECHARGE DLY

Current Limit Parameter

MAIN C/L(x10A)

Speed Parameters

The 1253 controller can accept inputs from up to four individual speed select switches (SS1–SS4) and from an analog throttle. The controller adjusts the pump motor's PWM output in response to these inputs, using the algorithm prescribed by the programmed acceleration rate to reach the appropriate maximum speed.

The programmed Minimum Speed and Acceleration Rate are in effect regardless of whether the speed request comes from a speed select switch or a throttle.

SS1–SS4 SPEED

The **SS Maximum Speed** parameter defines the maximum allowed armature PWM output of the pump motor. It can be set independently for up to four individual speed select switches (i.e., SS1 SPEED, SS2 SPEED, etc.). The maximum speed parameter is adjustable from 0% to 100% of the full output.

THRTL MAX SPEED

The **Throttle Maximum Speed** parameter defines the maximum allowed armature PWM output in response to throttle input. The maximum speed parameter is adjustable from 0% to 100% of the controller's full output.

MINIMUM SPEED

The **Minimum Speed** parameter defines the minimum allowed armature PWM output of the pump motor, and is adjustable from 0 to 50% of the full output. The minimum speed feature ensures that adequate pressure is maintained for the power steering system and for pump lubrication.

ACCEL RATE

The **Acceleration Rate** parameter defines the time it takes for the controller to accelerate from 0% output to 100% output when a speed select switch is closed or a full throttle request is made. The acceleration rate is adjustable from 0.2 to 3.0 seconds.

Throttle Parameters

Most applications use a throttle to provide variable speed control of a specific hydraulic operation (e.g., lift, reach, tilt, shift, rotate). A throttle gives the operator more flexibility and control over performance than is provided by switch inputs.

THROTTLE TYPE

The 1253 controller accepts a variety of throttle inputs, including 5k Ω –0 and 0–5k Ω two-wire rheostats, 3-wire pots, and 0–5V throttles. The standard throttle input signal type options—Types “0” through “3” in the Program Menu—are

listed in Table 2. Wiring information and performance characteristics for each type are presented in Section 2.

If no throttle is used in the application, the throttle fault parameter (see page 25) should be programmed Off; otherwise the controller will register a throttle fault.

| THROTTLE TYPE | DESCRIPTION |
|---------------|---|
| 0 | 0–5k Ω , 2-wire rheostat |
| 1 | 5k Ω –0, 2-wire rheostat |
| 2 | single-ended 0–5V input) |
| 3 | single-ended 3-wire potentiometer (1k Ω to 10k Ω range) |

THRTL DEADBAND

The **Throttle Deadband** parameter defines the pot wiper voltage range the controller interprets as neutral. Increasing the throttle deadband setting increases the neutral range. This parameter is especially useful with throttle assemblies that do not reliably return to a well-defined neutral point, because it allows the

Fig. 8 *Effect of adjusting the throttle deadband parameter (throttle types 0 and 1).*

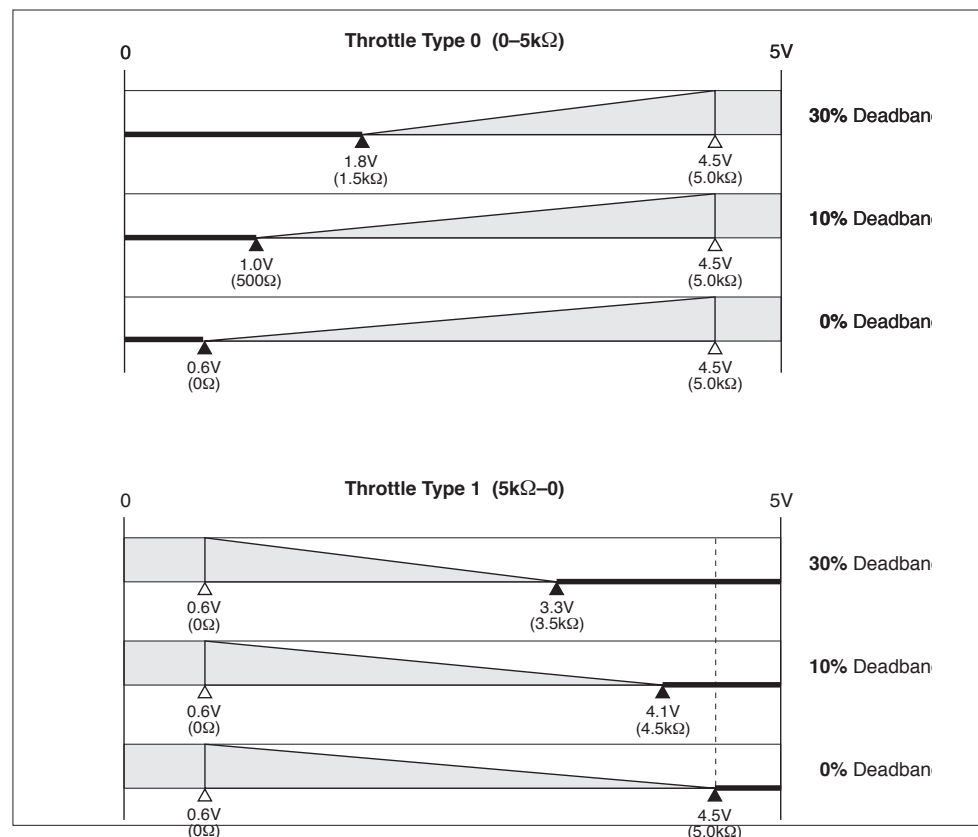
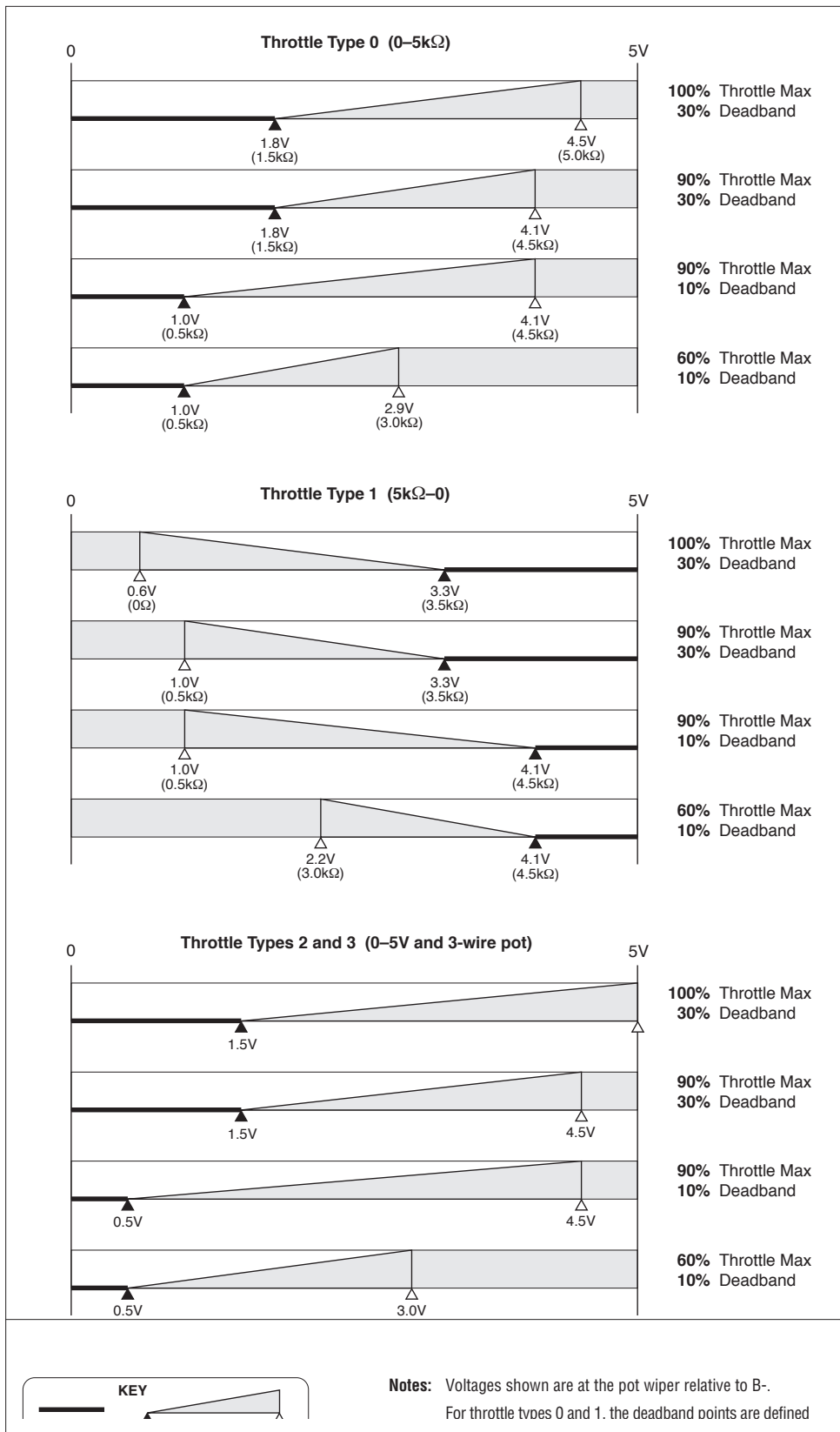

Fig. 9 Effect of adjusting the throttle max parameter.



THROTTLE MAP

The **Throttle Map** parameter modifies the response to the throttle input. This parameter determines the controller output for a given amount of applied throttle. Setting the throttle map parameter at 50% provides a linear output response to throttle position. Values below 50% reduce the controller output at low throttle requests, providing enhanced slow speed control. Values above 50% give the function a faster, jumpier feel at low throttle requests.

The throttle map can be programmed in 5% increments between 20% and 80%. The number refers to the controller output at half throttle, as a percentage of the throttle's full active range. The throttle's active range is the voltage or resistance between the 0% output point (throttle deadband) and the 100% output point (throttle max). For example, if maximum speed is set at 100%, a throttle map setting of 50% will give 50% output at half throttle. The 50% setting corresponds to a linear response. Six throttle map profiles (20, 30, 40, 50, 60, and 80%) are shown as examples in Figure 10, with the maximum speed set at 100%.

Fig. 10 *Throttle maps for controller with maximum speed set at 100%.*

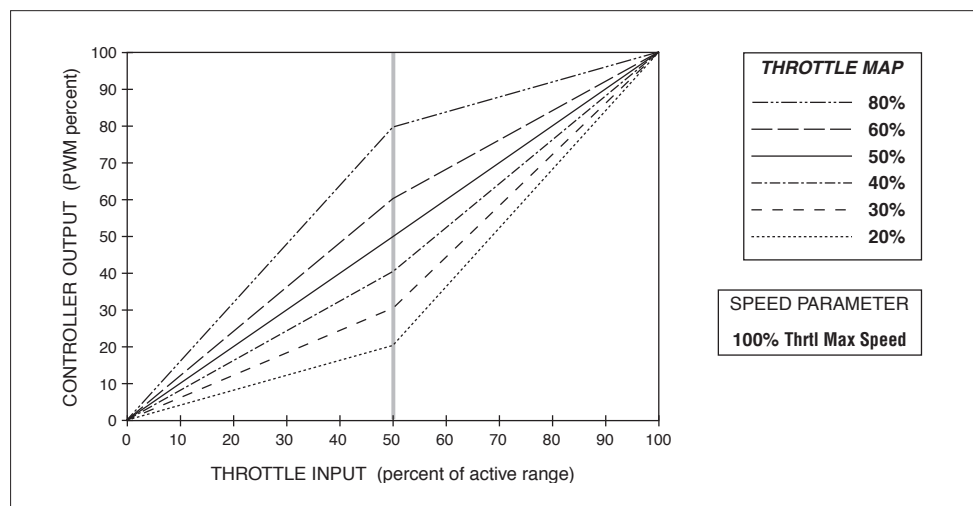

Lowering the max speed limits the controller's output range. Throttle map profiles with the max speed reduced from 100% to 80% are shown in Figure 11. The throttle map is always a percentage of the controller's output range. So, in these examples, the throttle map is a percentage of the 0–80% output range; a 40% throttle map setting will give 32% output at half throttle (40% of 80% = 32%). Controller output will begin to increase as soon as the throttle is rotated out of its normal neutral range (deadband). Controller output will continue to increase, following the curve defined by the throttle map setting, as the throttle input increases and will reach maximum output when the throttle input enters the upper deadband (crosses the throttle max threshold).

Fig. 11 Throttle maps for controller with maximum speed set at 80%.

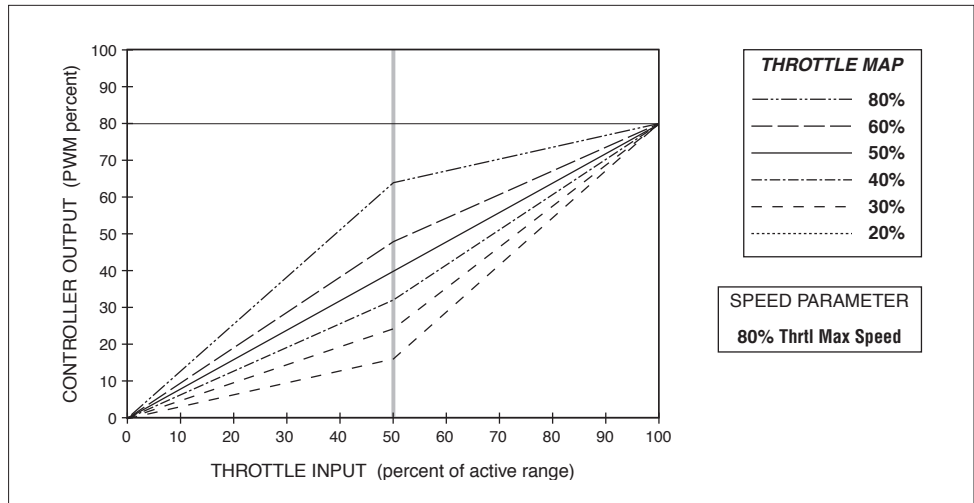

The throttle map operates within the window established by the Throttle Max Speed, Throttle Deadband, and Throttle Max parameters, as shown below in Figure 17. Throttle Max Speed defines the controller's output range, while Throttle Deadband and Throttle Max define the throttle's active range. These three parameters, together with the Throttle Map parameter, determine the controller's output response to throttle demand.

Fig. 12 Influence of various parameters on controller output response to throttle demand.

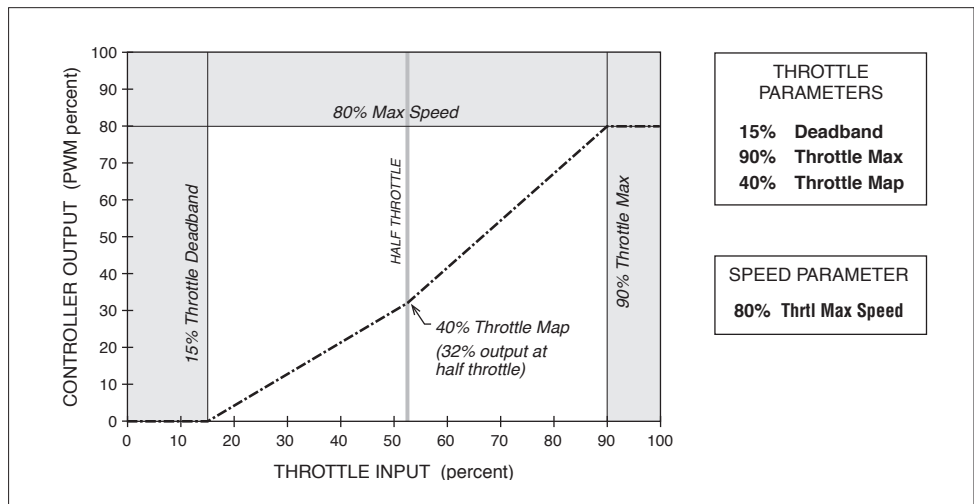

Final Speed Request Parameters

The final speed request parameters define how the controller will handle multiple requests—from more than one speed select switch or from a combination of speed select switches and the throttle. It is this single final calculated speed that is demanded of the pump motor.

When multiple requests are received, the controller can add them (“Add Mode”) or accept only the first request (“First On Mode”), depending on how the Add Mode parameters are set.

For 1253-4804 controllers, the controller will enter SS High Speed On mode if the SS High Speed On parameter is set to On; otherwise, its speed request mode is the same as above.

SS ADD MODE

The **Speed Select Add Mode** parameter enables Add Mode for speed select switches SS1–SS4. Add Mode is enabled or disabled (programmed On or Off) for all four switches as a group.

When SS Add Mode is Off, the controller responds to the first request it receives and ignores—or “locks out”—any subsequent requests; this is called “First On Mode.” If SS3 is the first speed select switch to be closed, the controller accelerates to the programmed SS3 maximum output. If SS2 is then closed, the controller output (and the pump speed) remain the same and the SS3 operation is slowed because it must share the available hydraulic pressure with the SS2 operation. If two or more speed select switches are closed simultaneously, the controller responds to the lowest-numbered switch (i.e., SS2 takes precedence over SS3, etc.).

When SS Add Mode is On, the controller increases the pump speed in order to maintain the level of work requested by each speed select switch input; this is called “Add Mode,” because the individual requests are added together. If SS3 is the first speed select switch to be closed, the controller accelerates to the programmed SS3 maximum output. If SS2 is then closed, the controller output (and the pump speed) increase so that each operation is performed at the same level of effort as if it were operating alone. The controller sends the pump the required amount of power (up to 100% of maximum output) to provide enough hydraulic pressure to perform all the requested operations at their individually-specified maximum speeds.

FINAL ADD MODE

Typically, some operations are controlled by speed select switches and others by the throttle. The **Final Add Mode** parameter determines whether the controller will respond to the first request it receives (either the SS request or the throttle request) or whether it will add them. If Final Add Mode is programmed Off, the pump speed will be defined by the first request it receives (SS or throttle).

If Final Add Mode is programmed On, the controller will sum the two requests (up to 100% output). The “final” speed request that is sent to the motor is, of course, temporary—the final request is constantly recalculated in response to changes in the inputs.

Speed conditioning is shown in detail in Figure 13.

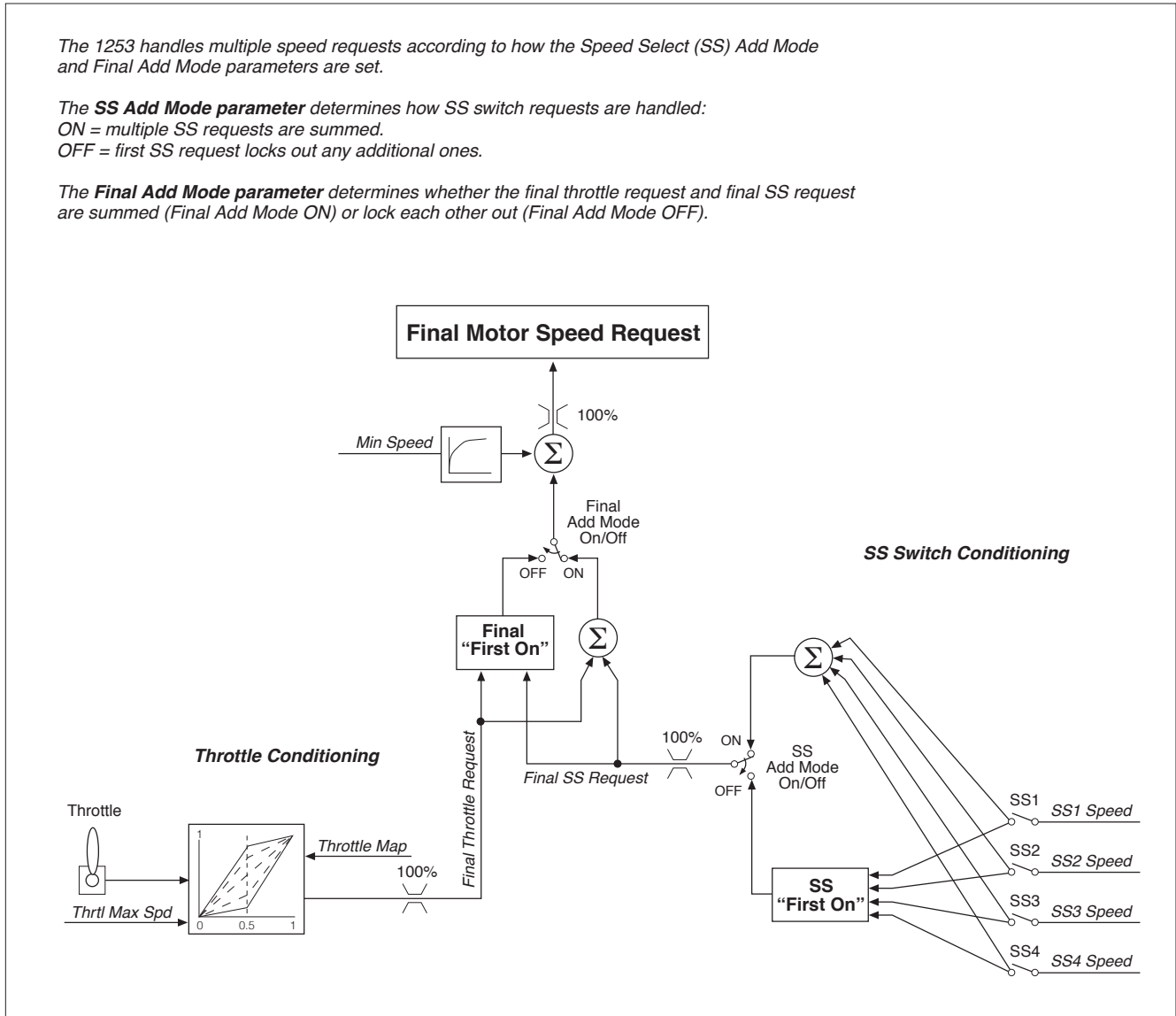

Fig. 13 Speed conditioning diagram.

SS HIGH SPEED ON (1253-4804 only)

In some applications using the 1253-4804 controller, it may be desirable to have the pump speed defined by the highest request. When the **SS High Speed On** parameter is programmed On, the controller will enter SS High Speed On mode. In this mode, if the Final Throttle request = 0, the pump speed will be defined by the highest speed request among all the active speed select (SS) requests; otherwise, the pump speed will be defined by the Final Throttle Request.

If SS High Speed On is programmed Off, the pump speed will be defined by Add Mode or First On Mode.

SS High Speed On speed conditioning is shown in detail in Figure 14.

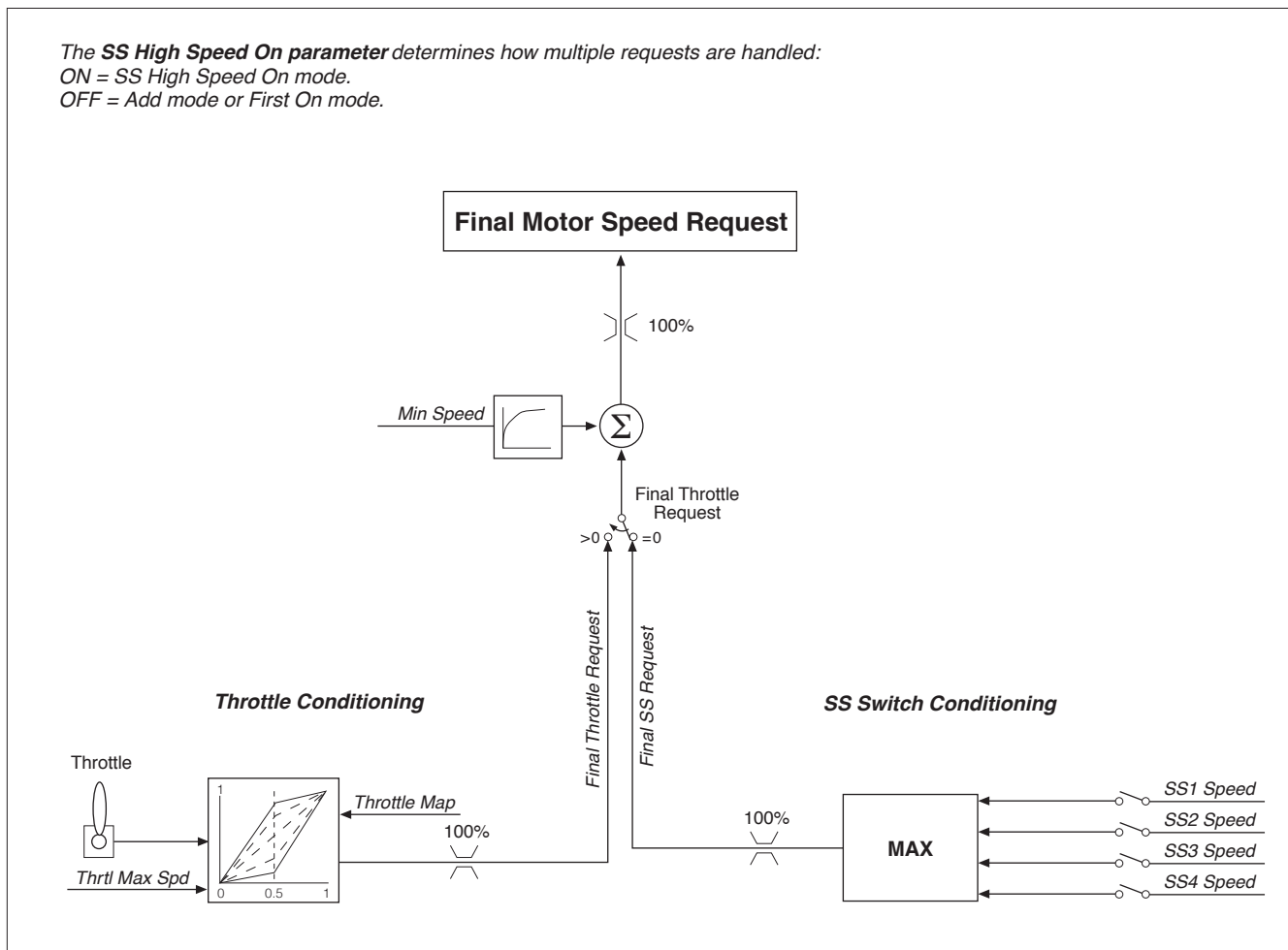

Fig. 14 SS High Speed On speed conditioning diagram.

Fault Parameters

LOCKOUT TYPE

The **Lift Lockout Type** parameter defines how the controller will interpret the lift lockout input signal at Pin J1-11. The lockout type options—Types “0” through “3” in the Program Menu—are listed in Table 3.

| LOCKOUT TYPE | DESCRIPTION | APPLICATION |
|--------------|---|---------------------------------|
| 0 | Low = enable lockout High/Open = disable lockout | Curtis 906, Curtis enGage™ IV |
| 1 | High/Open = enable lockout Low = disable lockout | Curtis 803, Curtis 841 Superspy |
| 2 | High = enable lockout Low/Open = disable lockout | — |
| 3 | Low/Open = enable lockout High = disable lockout | — |

The lockout type should be programmed appropriately for the gauge you are using to provide lift lockout. With the Curtis 906 and enGage™ IV, set the lockout type to 0. With the Curtis 803 and 841 “Superspy,” set the lockout type to 1. The other two types are available for other system configurations.

LIFT LOCK (SS1–SS4)

The lift lockout feature is designed to prevent Lift operation during undervoltage conditions. The **SS Lift Lockout** parameter can be programmed On or Off independently for each of the speed select switches. When programmed On, if Pin J1-11 receives an enable lockout signal during a Lift operation, the Lift in progress will be completed but further Lift requests will be ignored as long as the lockout enable signal is present. If programmed Off, the Lift will continue to operate just as if Pin J1-11 were not receiving a lockout signal.

When SS4 is used for power steering, PWM output will be shut down when lift lockout is activated. If you do not want low battery lockout of power steering, SS4 lift lockout should be programmed Off.

THRTL LIFTLOCK

The **Throttle Lift Lockout** parameter can be programmed On or Off, and works just like SS lift lockout. When programmed On, if Pin J1-11 receives an enable lockout signal during a Lift operation, the Lift in progress will be completed but further Lift requests will be ignored as long as the lockout enable signal is present. If programmed Off, the Lift will continue to operate just as if Pin J1-11 were not receiving a lockout signal.

THRTL FAULT

When the **Throttle Fault Detection** parameter is programmed On, the 1253 issues a fault if there is a problem with the throttle or its wiring. This parameter should be programmed Off if there is no throttle in the system, to prevent a throttle fault from being issued on a nonexistent throttle.

Regardless of how the throttle fault parameter is set, if there is no connection to the throttle the throttle input is assumed to be zero.

If the throttle fault parameter is programmed Off, the throttle input is assumed to be zero even if a throttle is connected.

STARTUP LOCKOUT

The startup lockout feature prevents the pump motor from running if any of the speed select inputs (SS1–SS4) is high or the throttle input is outside the neutral deadband when the controller is turned on. The **Startup Lockout** parameter is used to set the type of lockout. Two types of lockout are available: lockout on KSI input alone or lockout on KSI plus interlock inputs. Startup lockout can also be disabled.

No Startup Lockout (Type 0)

Startup lockout function is disabled.

KSI-type Startup Lockout (Type 1)

To start the pump motor, the controller must receive a KSI input before receiving a speed select input or a throttle input outside the neutral deadband. Controller operation will be disabled immediately if an inappropriate speed request is active at the time KSI is enabled, and a sequence error fault will be declared. If the inappropriate speed request is received before the interlock switch is closed but after the KSI input has been enabled, the motor will accelerate to the requested speed as soon as the interlock switch is closed. Normal operation is regained by reducing any throttle request to within the neutral deadband and opening any speed select switches that were already closed.

Interlock-type Startup Lockout (Type 2)

To start the pump motor, the controller must receive an interlock switch input in addition to a KSI input before receiving a speed select input or a throttle input outside the neutral deadband. Controller operation will be disabled immediately if an inappropriate speed request is active at the time the interlock switch is closed, and a sequence error fault will be declared. Normal operation is regained by reducing any throttle requests to within the neutral deadband and opening any speed select switches that were already closed.

Undervoltage Parameters

LOVOLT CUTBACK

The **Low Voltage Cutback** parameter sets the undervoltage threshold. At this threshold voltage, the output current starts to taper off. Output current is reduced until reaching zero, at the rate established by the low voltage cutback rate parameter (see below). Low voltage cutback can be set from 32–42 V for 48V models and from 54–70 V for 80V models.

LOVOLT CB RATE

The **Low Voltage Cutback Rate** parameter determines how sharply the current limit decreases when the battery voltage falls below the undervoltage threshold (see above). The low voltage cutback rate can be set from 0 to 20, with cutback response being more gradual at lower values and more abrupt at higher values. A setting of 0 disables the cutback function entirely; this is not recommended, as the cutback function protects the system from operating at voltages lower than its electronics were designed for.

Contactor Control Parameters

CONTACT CNTRL

The **Main Contactor Control** parameter is programmed to correspond to the way the contactor is wired. If the contactor is part of the 1253 circuit, this parameter should be programmed On. If the contactor is controlled externally, this parameter should be programmed Off.

CONT PULL IN

The **Main Contactor Pull-in Voltage** parameter allows a high initial voltage when the contactor driver first turns on, to ensure contactor closure. After the controller detects that the contactor is closed, this peak voltage will be applied for 0.1 second to ensure a reliable close; the voltage will then drop to the programmed contactor holding voltage (see below).

For 48V models, the pull-in voltage can be set from 18–60 V. For 80V models, the range is 30–100 V.

CONT HOLDING

The **Contactor Holding Voltage** parameter allows a reduced average voltage to be applied to the contactor coil once it has closed. The holding voltage must be set high enough to hold the contactor closed under all shock and vibration conditions it will be subjected to.

For 48V models, the contactor holding voltage range is 12–60V, with 48V being the typical default setting. For 80V models, the range is 20–100V, with 80V being the typical default setting.

SS4 DELAY

The **SS4 Delay** parameter can be set to allow the SS4 output to continue for a period of time after the SS4 switch is opened. The delay is useful for maintaining power to auxiliary functions, such as a steering pump motor, that may be used for a short time after the operator has gotten up from the seat. The SS4 delay can be set from 0.0 to 60.0 seconds, with 0.0 corresponding to no delay.

INTERLOCK DLY

The **Interlock Delay** parameter can be set to allow the PWM output to continue for a period of time (the interlock delay) after the interlock switch is opened. The delay is useful for maintaining power to auxiliary functions, such as a steering pump motor, that may be used for a short time after the operator has gotten up from the seat. The interlock delay can be set from 0.0 to 60.0 seconds, with 0.0 corresponding to no delay.

PRECHARGE

The **Precharge** parameter enables or disables the precharge function. Precharge provides a limited current charge of the controller's internal capacitor bank before the main contactor is closed. This decreases the arcing that would otherwise occur when the contactor is closed with the capacitor bank discharged.

Precharging and the precharge fault detection depend on the setting of both the precharge and the contactor control parameters, as shown in Table 4.

| PARAMETER SETTING | | PRECHARGE PERFORMED | PRECHARGE FAULT DETECTION |
|-------------------|---------------|---------------------|---------------------------|
| PRECHARGE | CONTACT CNTRL | | |
| ON | ON | YES | YES |
| ON | off | YES | YES |
| off | ON | no | no |
| off | off | YES | no |

PRECHARGE DLY

The controller can be programmed to delay for a set time at powering on before charging the capacitor bank. The **Precharge Delay** parameter defines the delay time; it can be set from 0 to 1000 ms.

Current Limit Parameter

MAIN C/L (x10A)

The **Main Current Limit (x10A)** parameter defines the maximum current the controller will supply to the pump motor. The programmed value multiplied by ten is the actual current limit. The programmable range for this parameter is 20–60, which means the actual range for the main current limit is 200–600 A.

4

INSTALLATION CHECKOUT

Carefully complete the following checkout procedure before operating the hydraulic system. If you find a problem during the checkout, refer to the diagnostics and troubleshooting section (Section 5) for further information.

The installation checkout is typically conducted with the handheld programmer. Otherwise, if you have connected an external Status LED to Pin J1-6, you can observe this LED for fault codes; the codes are listed in Section 5.

Before starting the procedure, check that the hydraulic hoses are secure, and the system primed with oil.



Drive the vehicle to a location that will provide enough room for all the hydraulic functions to be tested; if indoors, be sure the ceiling height is adequate.

Do not stand, or allow anyone else to stand, directly in front of or beside the vehicle during the checkout.

Make sure the keyswitch is off, the throttles are in neutral, and all the hydraulic system switches (Lift, Lower, Reach, Tilt, Shift, Rotate, etc.) are open.

Wear safety glasses and use well-insulated tools.

1. If a programmer is available, connect it to the programmer connector.
2. Turn the keyswitch on. The controller should power up, the programmer should present an initial display, and the Status LED should begin blinking a single flash.
 - If not, check for continuity in the keyswitch circuit and controller ground.
3. If you are using a programmer, scroll to the Faults Menu. The display should indicate “No Known Faults.” Close the interlock switch (if one is used in your application). The Status LED should continue blinking a single flash and the programmer should continue to indicate no faults.
 - If there is a problem, the LED will flash a fault code and the programmer will display a fault message. If you are conducting the checkout without a programmer, look up the LED fault code in Section 5.
 - When the problem has been corrected, it may be necessary to cycle the keyswitch in order to clear the fault.
4. If you are using a programmer, scroll to the Monitor Menu. Scroll down to observe the status of the interlock and four speed select switches

(SS1–SS4). Cycle each switch in turn, observing the programmer. The programmer should display the correct status for each switch.

5. Use the throttle to operate the pump motor. It should accelerate smoothly.
6. Verify that Startup Lockout performs as desired.
7. Request multiple operations in various combinations, to confirm that motor speed responds according to the settings you made for the SS Add Mode and Final Add Mode parameters.
8. If you used a programmer, disconnect it when you have completed the checkout procedure.

BENCH TESTING WITH THE 1311 PROGRAMMER

With the simple bench test setup shown in Figure 14, the controller parameters can be verified or adjusted without the controller being wired into a vehicle.

The complete in-vehicle installation checkout, as described above in Steps 1–8, should still be conducted before the vehicle is operated.

Fig. 14 Bench test setup for verifying and adjusting the controller's parameters.

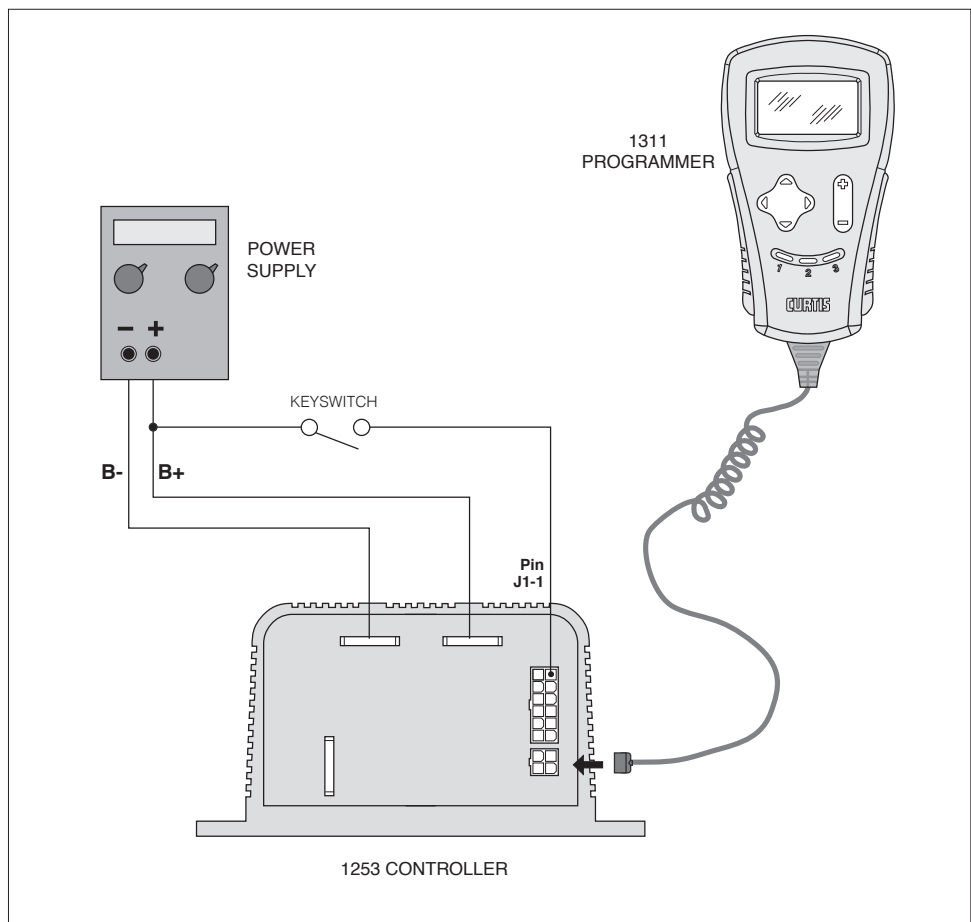

5

DIAGNOSTICS AND TROUBLESHOOTING

The 1253 controller provides diagnostics information to assist technicians in troubleshooting pump system problems. The diagnostics information can be obtained by observing the appropriate display on the handheld programmer or the fault codes issued by the optional Status LED. Refer to the troubleshooting chart (Table 5) for suggestions covering a wide range of possible faults.

PROGRAMMER DIAGNOSTICS

The programmer presents complete diagnostic information in plain language. Faults are displayed in the Faults Menu (see column 2 in the troubleshooting chart), and the status of the controller inputs/outputs is displayed in the Monitor Menu.

Accessing the Fault History Menu provides a list of the faults that have occurred since the fault history file was last cleared. Checking (and clearing) the fault history file is recommended each time the vehicle is brought in for maintenance.

The following 4-step process is recommended for diagnosing and troubleshooting an inoperative pump system: (1) visually inspect the vehicle for obvious problems; (2) diagnose the problem, using the programmer; (3) test the circuitry with the programmer; and (4) correct the problem. Repeat the last three steps as necessary until the pump system is operational.

Example: A vehicle that cannot perform the operation requested by Speed Select 2 is brought in for repair.

STEP 1: Examine the vehicle and its wiring for any obvious problems, such as broken wires or loose connections.

STEP 2: Connect the programmer, select the Faults Menu, and read the displayed fault information. In this example, the display shows “No Known Faults,” indicating that the controller has not detected anything out of the norm.

STEP 3: Select the Monitor Menu, and observe the status of the SS2 input. In this example, the display shows that the switch does not close when SS2 is selected, which means the problem is either in the SS2 switch or the switch wiring.

STEP 4: Check or replace the SS2 switch and wiring and repeat the test. If the programmer shows the SS2 switch closing and the system now operates normally, the problem has been corrected.

Table 5 TROUBLESHOOTING CHART

| LED CODE | PROGRAMMER LCD DISPLAY | EXPLANATION | POSSIBLE CAUSE |
|----------|------------------------|--|--|
| 1,1 | EEPROM FAULT | EEPROM fault. <i>Note: Usually can be cleared by modifying any parameter value in the Program Menu.</i> | <ol style="list-style-type: none"> EEPROM data lost or damaged. EEPROM checksum error. |
| 1,2 | HW FAILSAFE | Self-test or watchdog fault. | <ol style="list-style-type: none"> MOSFET shorted. Controller defective. |
| 1,3 | MOTOR SHORTED | Motor shorted. | <ol style="list-style-type: none"> Motor is shorted. |
| 2,1 | UNDERVOLTAGE CUTOFF | Undervoltage cutoff. | <ol style="list-style-type: none"> Battery voltage < LOVOLT CUTOFF setting. |
| 2,2 | LIFT LOCKOUT | Lift operation locked out due to undervoltage. | <ol style="list-style-type: none"> Controller received appropriate lift lockout signal. Inappropriate lift lockout signal: SS LOCKOUT parameter not set correctly. |
| 2,3 | SEQUENCE ERROR | Startup lockout. | <ol style="list-style-type: none"> Improper sequence of throttle or SS and KSI or KSI plus interlock. STARTUP LOCKOUT parameter not set correctly. Misadjusted throttle. |
| 2,4 | THROTTLE FAULT | Wiper signal out of range (pot low fault). | <ol style="list-style-type: none"> Throttle input wire open or shorted. Throttle defective. THROTTLE TYPE parameter not set correctly. |
| 3,1 | CONT DRVR OC | Main contactor coil overcurrent. | <ol style="list-style-type: none"> Main contactor coil shorted. Controller defective. |
| 3,2 | MAIN CONT WELDED | Main contactor welded. | <ol style="list-style-type: none"> Main contactor stuck closed. CONT CNTRL parameter not set correctly. Main contactor driver shorted. |
| 3,3 | PRECHARGE FAULT | Precharge fault. | <ol style="list-style-type: none"> Precharge circuit failure. External short or leakage between B+ and B-. |
| 3,4 | MAIN CONT DNC | Main contactor did not close. | <ol style="list-style-type: none"> Main contactor coil connection loose. Main contactor did not close. CONT CNTRL parameter not set correctly. |
| 4,1 | LOW BATTERY VOLTAGE | Low battery voltage. | <ol style="list-style-type: none"> Battery voltage < undervoltage cutback threshold. Corroded battery terminal. Loose battery or controller terminal. |
| 4,2 | OVERVOLTAGE | Overvoltage. | <ol style="list-style-type: none"> Battery voltage > overvoltage shutdown threshold. Vehicle operating with charger attached. |
| 4,3 | THERMAL CUTBACK | Over-/undertemperature cutback. | <ol style="list-style-type: none"> Temperature > 85°C or < -25°C. Excessive load on pump motor. Improper mounting of controller Operation in extreme environment. Thermistor failure. |

LED DIAGNOSTICS

The 1253 controller has a Status LED output that can be used to drive an external LED. This Status LED displays fault codes when there is a problem with the controller or with the inputs to the controller. During normal operation, with no faults present, the Status LED flashes steadily on and off.

If the controller detects a fault, a 2-digit fault identification code is flashed continuously until the fault is corrected. For example, code “3,2”—welded main contactor—appears as:

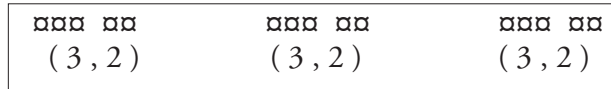

The codes are listed in Table 6.

| LED CODES | | EXPLANATION |
|-----------------|------------|--|
| <i>LED off</i> | ██████████ | no power or defective controller controller or microprocessor fault |
| <i>solid on</i> | □□□□□□ | |
| 0,1 | ■ □ | controller operational; no known faults |
| 1,1 | □ □ | EEPROM fault |
| 1,2 | □ □□ | hardware failsafe fault |
| 1,3 | □ □□□ | motor shorted |
| 1,4 | □ □□□□ | [not used] |
| 2,1 | □□ □ | undervoltage |
| 2,2 | □□ □□ | lift lockout |
| 2,3 | □□ □□□ | sequence error (startup lockout) |
| 2,4 | □□ □□□□ | throttle fault |
| 3,1 | □□□ □ | main contactor coil shorted |
| 3,2 | □□□ □□ | welded main contactor |
| 3,3 | □□□ □□□ | precharge fault |
| 3,4 | □□□ □□□□ | main contactor missing or did not close |
| 4,1 | □□□□ □ | low battery voltage |
| 4,2 | □□□□ □□ | overvoltage |
| 4,3 | □□□□ □□□ | thermal cutback, due to over/under temp |
| 4,4 | □□□□ □□□□ | [not used] |

Note: Only one fault is indicated at a time, and faults are not queued up. Refer to the troubleshooting chart (Table 5) for suggestions about possible causes of the various faults.

6

MAINTENANCE

There are no user serviceable parts in the Curtis 1253 controller. **No attempt should be made to open, repair, or otherwise modify the controller.** Doing so may damage the controller and will void the warranty.

It is recommended that the controller be kept **clean and dry** that its fault history file be checked and cleared periodically.

CLEANING

Periodically cleaning the controller exterior will help protect it against corrosion and possible electrical control problems created by dirt, grime, and chemicals that are part of the operating environment and that normally exist in battery powered systems.



When working around any battery powered system, proper safety precautions should be taken. These include, but are not limited to: proper training, wearing eye protection, and avoiding loose clothing and jewelry.

Use the following cleaning procedure for routine maintenance. Never use a high pressure washer to clean the controller.

1. Remove power by disconnecting the battery.
2. Discharge the capacitors in the controller by connecting a load (such as a contactor coil) across the controller's **B+** and **B-** terminals.
3. Remove any dirt or corrosion from the power and signal connector areas. The controller should be wiped clean with a moist rag. Dry it before reconnecting the battery.
4. Make sure the connections are tight.

FAULT HISTORY

The programmer can be used to access the controller's fault history file. The programmer will read out all the faults that the controller has experienced since the last time the fault history file was cleared. The faults may be intermittent faults, faults caused by loose wires, or faults caused by operator errors. Faults such as contactor faults may be the result of loose wires; contactor wiring should be carefully checked. Faults such as startup lockout or overtemperature may be caused by operator habits or by overloading.

After a problem has been diagnosed and corrected, it is a good idea to clear the diagnostic history file. This allows the controller to accumulate a new file of faults. By checking the new fault history file at a later date, you can readily determine whether the problem was indeed fixed.

APPENDIX A

VEHICLE DESIGN CONSIDERATIONS REGARDING ELECTROMAGNETIC COMPATIBILITY (EMC) AND ELECTROSTATIC DISCHARGE (ESD)

ELECTROMAGNETIC COMPATIBILITY (EMC)

Electromagnetic compatibility (EMC) encompasses two areas: emissions and immunity. *Emissions* are radio frequency (RF) energy generated by a product. This energy has the potential to interfere with communications systems such as radio, television, cellular phones, dispatching, aircraft, etc. *Immunity* is the ability of a product to operate normally in the presence of RF energy.

EMC is ultimately a system design issue. Part of the EMC performance is designed into or inherent in each component; another part is designed into or inherent in end product characteristics such as shielding, wiring, and layout; and, finally, a portion is a function of the interactions between all these parts. The design techniques presented below can enhance EMC performance in products that use Curtis motor controllers.

Emissions

Signals with high frequency content can produce significant emissions if connected to a large enough radiating area (created by long wires spaced far apart). Contactor drivers and the motor drive output from Curtis controllers can contribute to RF emissions. Both types of output are pulse width modulated square waves with fast rise and fall times that are rich in harmonics. (Note: contactor drivers that are not modulated will not contribute to emissions.) The impact of these switching waveforms can be minimized by making the wires from the controller to the contactor or motor as short as possible and by placing the wires near each other (bundle contactor wires with Coil Return; bundle motor wires separately).

For applications requiring very low emissions, the solution may involve enclosing the controller, interconnect wires, contactors, and motor together in one shielded box. Emissions can also couple to battery supply leads and throttle circuit wires outside the box, so ferrite beads near the controller may also be required on these unshielded wires in some applications. It is best to keep the noisy signals as far as possible from sensitive wires.

Immunity

Immunity to radiated electric fields can be improved either by reducing overall circuit sensitivity or by keeping undesired signals away from this circuitry. The controller circuitry itself cannot be made less sensitive, since it must accurately detect and process low level signals from sensors such as the throttle potentiometer. Thus immunity is generally achieved by preventing the external RF energy from coupling into sensitive circuitry. This RF energy can get into the controller circuitry via conducted paths and radiated paths.

Conducted paths are created by the wires connected to the controller. These wires act as antennas and the amount of RF energy coupled into them is generally proportional to their length. The RF voltages and currents induced in each wire are applied to the controller pin to which the wire is connected. Curtis controllers include bypass capacitors on the printed circuit board's throttle wires to reduce the impact of this RF energy on the internal circuitry. In some applications, additional filtering in the form of ferrite beads may also be required on various wires to achieve desired performance levels.

Radiated paths are created when the controller circuitry is immersed in an external field. This coupling can be reduced by placing the controller as far as possible from the noise source or by enclosing the controller in a metal box. Some Curtis controllers are enclosed by a heatsink that also provides shielding around the controller circuitry, while others are partially shielded or unshielded. In some applications, the vehicle designer will need to mount the controller within a shielded box on the end product. The box can be constructed of just about any metal, although steel and aluminum are most commonly used.

Most coated plastics do not provide good shielding because the coatings are not true metals, but rather a mixture of small metal particles in a non-conductive binder. These relatively isolated particles may appear to be good based on a dc resistance measurement but do not provide adequate electron mobility to yield good shielding effectiveness. Electroless plating of plastic will yield a true metal and can thus be effective as an RF shield, but it is usually more expensive than the coatings.

A contiguous metal enclosure without any holes or seams, known as a Faraday cage, provides the best shielding for the given material and frequency. When a hole or holes are added, RF currents flowing on the outside surface of the shield must take a longer path to get around the hole than if the surface was contiguous. As more "bending" is required of these currents, more energy is coupled to the inside surface, and thus the shielding effectiveness is reduced. The reduction in shielding is a function of the longest linear dimension of a hole rather than the area. This concept is often applied where ventilation is necessary, in which case many small holes are preferable to a few larger ones.

Applying this same concept to seams or joints between adjacent pieces or segments of a shielded enclosure, it is important to minimize the open length of these seams. Seam length is the distance between points where good ohmic contact is made. This contact can be provided by solder, welds, or pressure contact. If pressure contact is used, attention must be paid to the corrosion characteristics of the shield material and any corrosion-resistant processes applied to the base material. If the ohmic contact itself is not continuous, the shielding effectiveness can be maximized by making the joints between adjacent pieces overlapping rather than abutted.

The shielding effectiveness of an enclosure is further reduced when a wire passes through a hole in the enclosure; RF energy on the wire from an external field is re-radiated into the interior of the enclosure. This coupling mechanism can be reduced by filtering the wire where it passes through the shield boundary.

Given the safety considerations involved in connecting electrical components to the chassis or frame in battery powered vehicles, such filtering will usually consist of a series inductor (or ferrite bead) rather than a shunt capacitor. If a capacitor is used, it must have a voltage rating and leakage characteristics that will allow the end product to meet applicable safety regulations.

The B+ (and B-, if applicable) wires that supply power to a control panel should be bundled with the other control wires to the panel so that all these wires are routed together. If the wires to the control panel are routed separately, a larger loop area is formed. Larger loop areas produce more efficient antennas which will result in decreased immunity performance.

Keep all low power I/O separate from the motor and battery leads. When this is not possible, cross them at right angles.

ELECTROSTATIC DISCHARGE (ESD)

Curtis PMC motor controllers contain ESD-sensitive components, and it is therefore necessary to protect them from ESD (electrostatic discharge) damage. Most of these control lines have protection for moderate ESD events, but must be protected from damage if higher levels exist in a particular application.

ESD immunity is achieved either by providing sufficient distance between conductors and the ESD source so that a discharge will not occur, or by providing an intentional path for the discharge current such that the circuit is isolated from the electric and magnetic fields produced by the discharge. In general the guidelines presented above for increasing radiated immunity will also provide increased ESD immunity.

It is usually easier to prevent the discharge from occurring than to divert the current path. A fundamental technique for ESD prevention is to provide adequately thick insulation between all metal conductors and the outside environment so that the voltage gradient does not exceed the threshold required for a discharge to occur. If the current diversion approach is used, all exposed metal components must be grounded. The shielded enclosure, if properly grounded, can be used to divert the discharge current; it should be noted that the location of holes and seams can have a significant impact on ESD suppression. If the enclosure is not grounded, the path of the discharge current becomes more complex and less predictable, especially if holes and seams are involved. Some experimentation may be required to optimize the selection and placement of holes, wires, and grounding paths. Careful attention must be paid to the control panel design so that it can tolerate a static discharge.

MOV, transorbs, or other devices can be placed between B- and offending wires, plates, and touch points if ESD shock cannot be otherwise avoided.

APPENDIX B

PROGRAMMING DEVICES & MENUS

Curtis programmers provide programming, diagnostic, and test capabilities for the 1253 controller. The power for operating the programmer is supplied by the host controller via a 4-pin connector. When the programmer powers up, it gathers information from the controller.

Two types of programming devices are available: the 1314 PC Programming Station and the 1313 handheld programmer. The Programming Station has the advantage of a large, easily read screen; on the other hand, the handheld programmer (with its 45×60mm screen) has the advantage of being more portable and hence convenient for making adjustments in the field.

Both programmers are available in User, Service, Dealer, and OEM versions. Each programmer can perform the actions available at its own level and the levels below that—a User-access programmer can operate at only the User level, whereas an OEM programmer has full access.

PC PROGRAMMING STATION (1314)

The Programming Station is an MS-Windows 32-bit application that runs on a standard Windows PC. Instructions for using the Programming Station are included with the software.

HANDHELD PROGRAMMER (1313)

The 1313 handheld programmer is functionally equivalent to the PC Programming Station; operating instructions are provided in the 1313 manual. The 1313 programmer replaces the 1311, an earlier model with fewer functions.

PROGRAMMER FUNCTIONS

Programmer functions include:

Parameter adjustment — provides access to the individual programmable parameters.

Monitoring — presents real-time values during vehicle operation; these include all inputs and outputs.

Diagnostics and troubleshooting — presents diagnostic information, and also a means to clear the fault history file.

Programming — allows you to save/restore custom parameter settings files and also to update the system software (not available on the 1311).

Favorites — allows you to create shortcuts to your frequently-used adjustable parameters and monitor variables (not available on the 1311).

The Program Menu and Monitor Menu are presented here. For Faults, see the Troubleshooting Chart in Section 5. The other programmer menus are self-explanatory.

Program Menu *(not all items available on all controllers)*

The 1253's programmable parameters are listed here in the order in which they are displayed by the programmer.

| | |
|------------------|--|
| MAIN CL(x10A) | Maximum current controller will supply to pump motor |
| SS1 SPEED | Speed Select 1 maximum speed, as % PWM |
| SS2 SPEED | Speed Select 2 maximum speed, as % PWM |
| SS3 SPEED | Speed Select 3 maximum speed, as % PWM |
| SS4 SPEED | Speed Select 4 maximum speed, as % PWM |
| THRTL MAX SPD | Throttle maximum speed, as % PWM |
| MINIMUM SPEED | Minimum speed, as % PWM |
| ACCEL RATE | Acceleration rate, in seconds |
| SS ADD MODE | (SS switch) On: Add mode, Off: First On mode |
| FINAL ADD MODE | (Final SS + throttle) On: Add Mode, Off: First On Mode |
| SS HIGH SPEED ON | SS High Speed On enable: On= SS High Speed On mode, Off= Add mode or First On mode |
| THRTL FAULT | Throttle fault detection: On/Off |
| THROTTLE TYPE | Throttle type, 0–3 ¹ |
| THRTL DEADBAND | Neutral deadband adjustment, as % of active range |
| THROTTLE MAX | Throttle input required for max output, as % of active range |
| THROTTLE MAP | Throttle map: 20–80% |
| SS1 LIFT LOCK | Lift lockout of SS1: On/Off |
| SS2 LIFT LOCK | Lift lockout of SS2: On/Off |
| SS3 LIFT LOCK | Lift lockout of SS3: On/Off |
| SS4 LIFT LOCK | Lift lockout of SS4: On/Off |
| THRTL LIFTLOCK | Lift lockout of throttle: On/Off |
| LOCKOUT TYPE | Lockout type, 0–3 ² |
| PRECHARGE | Precharge enable: On/Off ³ |
| PRECHARGE DLY | Precharge delay time: 0–1000 ms |
| STARTUP LOCK | Startup lockout type, 0–2 ⁴ |
| CONTACT CNTRL | Main contactor controlled internally: On/Off ³ |
| SS4 DELAY | Delay between SS4 open and corresponding output shutdown, in seconds |
| INTERLOCK DLY | Delay between interlock open and output shutdown, in seconds |
| LOVOLT CUTBACK | Undervoltage cutback starting point, in volts |
| LOVOLT CB RATE | Low voltage cutback rate, 0–20 |
| CONT PULL IN | Contactor pull-in voltage |
| CONT HOLDING | Contactor holding voltage |

Program Menu Notes

¹ Throttle types (see Throttle Wiring in Section 2)

Type 0: 0–5kΩ, 2-wire pot

Type 1: 5kΩ–0, 2-wire pot

Type 2: single-ended 0–5V input

Type 3: single-ended 3-wire pot (1–10kΩ)

² Lift lockout types (see Section 3: Programmable Parameters, page 25)

Type 0: Enable = low; Disable = high or open

Type 1: Enable = high or open; Disable = low

Type 2: Enable = high; Disable = low or open

Type 3: Enable = low or open; Disable = high

³ Precharge function and fault detection depend on the combined setting of two parameters, Precharge and Contactor Control (see Section 3: Programmable Parameters, pages 28, 27)

| Parameter Setting | | Precharge Performed | Precharge Fault Detection |
|-------------------|---------------|---------------------|---------------------------|
| PRECHARGE | CONTACT CNTRL | | |
| ON | off | YES | YES |
| ON | ON | YES | YES |
| off | off | YES | no |
| off | ON | no | no |

⁴ Startup lockout types (see Section 3: Programmable Parameters, page 26)

Type 0: no startup lockout

Type 1: startup lockout unless KSI input is received before speed request

Type 2: startup lockout unless KSI and interlock inputs are both received before speed request

Monitor Menu

Items are listed here in the order in which they appear in the Monitor Menu displayed by the programmer.

| | |
|----------------|---|
| HEATSINK TEMP | Heatsink temperature, in °C. |
| CAP VOLTAGE | Voltage at capacitor bank (controller B+ bus). |
| BATT VOLTAGE | Voltage at KSI (pin J1-1). |
| MOTOR VOLTAGE | Voltage across controller's B+ and M- bus bars. |
| THROTTLE% | Throttle request, as % of full throttle. |
| MAIN CONT DRVR | Main contactor output: on/off. |
| DUTY CYCLE % | PWM duty cycle of motor drive section. |
| SS1 INPUT | Speed Select switch 1: on/off. |
| SS2 INPUT | Speed Select switch 2: on/off. |
| SS3 INPUT | Speed Select switch 3: on/off. |
| SS4 INPUT | Speed Select switch 4: on/off. |
| LIFTLOCK INPUT | Lift lockout: on/off. |
| INTERLCK INPUT | Interlock switch: on/off. |

APPENDIX C

SPECIFICATIONS

Table C-1 SPECIFICATIONS: 1253 CONTROLLER

| | |
|---|---|
| Nominal input voltage | 48 V and 80 V |
| PWM operating frequency | 15.6 kHz |
| Electrical isolation to heatsink | 500 V ac (minimum) |
| KSI input voltage | 28 V (minimum) for 48V model; 47 V (minimum) for 80V model |
| KSI input current (no contactors engaged) | <60 mA without 1311 programmer; <130 mA with 1311 programmer |
| Logic input voltage | see below |
| Logic input current | <1 mA |
| Contactor driver output current | 1 A (maximum) |
| Status LED output current | 5 mA (maximum) |
| Operating ambient temperature range | -40°C to 50°C (-40°F to 122°F) |
| Storage ambient temperature range | -40°C to 85°C (-40°F to 185°F) |
| Heatsink overtemperature cutback | linear cutback starts at 80°C (176°F); complete cutoff at 120°C (248°F) |
| Heatsink undertemperature cutback | 50% current below -25°C (-13°F) |
| Package environmental rating | IP54 |
| Weight | 2.6 kg (5.7 lb) |
| Dimensions (L×W×H) | 196 × 146 × 77 mm (7.7" × 5.7" × 3.0") |

| MODEL NUMBER | NOMINAL BATTERY VOLTAGE (volts) | ARMATURE CURRENT LIMIT (amps) | KSI INPUT VOLTAGE (volts) | PROGRAMMABLE UNDERVOLTAGE CUTBACK (volts) | OVERVOLTAGE CUTOFF (volts) |
|--------------|---------------------------------|-------------------------------|---------------------------|---|----------------------------|
| 1253-48XX | 48 | 600 | 28–60 | 32–42 | 60 |
| 1253-80XX | 80 | 600 | 47–102 | 54–70 | 102 |